



User Manual

IK618 Key Programming Tool



Please read this user manual carefully before using the IK618 Smart Diagnostic System. When reading the manual, please pay attention to the words “Note” or “Caution”, and read them carefully for appropriate operation.

TRADEMARKS

XTOOL is a registered trademark of Shenzhen Xtooltech Intelligent CO., LTD.

In countries where the trademarks, service marks, domain names, logos and the name of the company are not registered, XTOOL claims that it still reserves the ownership of the unregistered trademarks, service marks, domain names, logos and the company name. All other marks for the other products and the company’s name mentioned in the manual still belong to the original registered company.

You may not use the trademarks, service marks, domain names, logo and company name of XTOOL or other companies mentioned without written permission from the trademark holder.

XTOOL reserves the right to the final interpretation of this manual content.

COPYRIGHT

Without the written consent of Shenzhen Xtooltech Intelligent Co., Ltd., any company or individual shall not copy or backup this operation manual in any form (electronic, mechanical, photocopying, recording, or other forms).

DECLARATION

This manual is designed for the usage of the IK618 Smart Diagnostic System and provides operating instructions and product descriptions for users of the IK618 Smart Diagnostic system.

No part of this manual can be reproduced, stored in a retrieval system, or transmitted, in any form or by any means (electronic, mechanical, photocopying, recording, or otherwise), without the prior written permission of XTOOL.

Use the device only as described in this manual. XTOOL is not responsible for any consequences of violating the laws and regulations caused by using the product or its data information

XTOOL shall not be liable for any incidental or consequential damages or for any economic consequential damages arising from the accidents of individual users and the third parties, misuse or abuse of the device, unauthorized change or repair of the device, or the failure made by the user not to use the product according to the manual.

All information, specifications, and illustrations in this manual are based on the latest configurations and functions available at the time of printing. XTOOL reserves the right to make changes at any time without notice.

OPERATION INSTRUCTIONS

For safe operation, please follow the instructions below:

- Keep the device away from heat or fumes when you use it.
- If the vehicle battery contains acid, please keep your hands and skin or fire sources away from the battery during testing.
- The exhaust gas of the vehicle contains harmful chemicals, please ensure adequate ventilation.
- Do not touch the cooling system components or exhaust manifolds when the engine is running due to the high temperatures reached.
- Make sure the car is securely parked, Neutral is selected or the selector is at P or N position to prevent the vehicle from moving when the engine starts.
- Make sure the (DLC) diagnostic link connector is functioning properly before starting the test to avoid damage to the Diagnostic Computer.
- Do not switch off the power or unplug the connectors during testing, otherwise, you may damage the ECU and/or the Diagnostic Computer.

CAUTIONS!

- Avoid shaking or dismantling the unit as it may damage the internal components.
- Do not use hard or sharp objects to touch the LCD screen;
- Do not use excessive force;
- Do not expose the screen to strong sunlight for a long period.
- Please keep it away from water, moisture, high temperature or very low temperature.
- If necessary, calibrate the screen before testing to ensure the accuracy of LCD performance.
- Keep the main unit away from strong magnetic fields.

AFTERSALES-SERVICES

E-Mail: support1@xtooltech.com

support2@xtooltech.com

Tel: +86 755 21670995 or +86 755 86267858 (China)

Official Website: www.xtooltech.com

CONTENT

TRADEMARKS	I
COPYRIGHT	I
DECLARATION	I
OPERATION INSTRUCTIONS	II
CAUTIONS!	III
AFTERSALES-SERVICES	III
CONTENT	I
1 GENERAL INTRODUCTION	1
Tablet.....	1
<i>Front View of Tablet</i>	1
<i>Back View of Tablet</i>	2
<i>Host Ports</i>	2
Accessories.....	3
<i>KC100 Transponder Generator</i>	3
<i>EEPROM Adapter</i>	4
Technical Specifications.....	4
Package List	5
2 GETTING STARTED	6
Activation	6
Main Interface	8
<i>Operation system</i>	8
<i>IK618 APP Menu</i>	9
<i>Function Buttons</i>	10
<i>Navigation Buttons</i>	11
<i>Notification Bar</i>	12
3 UPDATE	13
4 KEY PROGRAMMING	14
Vehicle Connection	14
<i>Connect To KC100</i>	15
<i>Connect To EEPROM Adapter</i>	15
Immobilizer Menu.....	16
Immobilizer Functions	17
<i>Read PIN code/Pin Code Calculation</i>	17

	<i>Check Number of Keys</i>	20
	<i>Add Keys</i>	21
	<i>All Key Lost</i>	23
5	DIAGNOSTIC	29
	Diagnostics	29
	<i>Vehicle Selection</i>	29
	<i>Diagnosis functions</i>	32
6	SPECIAL FUNCTIONS	41
	5.1 OIL RESET	41
	5.2 EPB.....	43
	5.3 SAS.....	45
	5.4 DPF.....	48
	5.5 BMS RESET	52
	5.6 THROTTLE	54
	5.7 INJECTOR CODING.....	56
	5.8 GEARBOX MATCH.....	58
	5.9 GEAR LEARNING.....	59
	5.10 EEPROM ADAPTER.....	61
7	SETTINGS	61
	Language	62
	Units.....	63
	My Workshop Info	63
	Firmware Information	64
	About.....	65
8	REPORT	66
	Report	66
	Replay.....	69
	File Manager	69
9	REMOTE ASSISTANCE	70
10	FAQ	72
	Q1: Failed to generate Diagnostic report	72
	Q2: How to print Diagnostic report	73
	Q3: Failed to extract files	73
	Q4: Mailbox supported.....	74
	Q5: How to make an appointment for remote support	74
	Q6: How to generate and upload diagnostic log files	74

Q7: How to switch language	74
Q8: SHOWING “COMMUNICATION FAILED”	75
Q9: Failed to activate or register	75
Q10: Failed to turn on when charging	75
Q11: Failed to open the Diagnostic app	76
Q12: HOW TO FACTORY RESET THE DEVICE	76
Q13: SHOWING “LICENSE EXCEPTION”	76
Q14: SHOWING “FAILED” WHEN GOING INTO MENUS.....	76
Q15: HOW TO FREE THE STORAGE SPACE	76
Q16: SOME OF THE SOFTWARE ARE MISSING	77
11 COMPLIANCE INFORMATION.....	77
FCC Compliance.....	77
CE	79
UKCA.....	79

1 GENERAL INTRODUCTION

The XTOOL IK618 key programming tool is an Android tablet with multiple key programming as well as diagnosis functions. It supports multi-language switching and is suitable for different countries and regions. This tool can be connected with the OBD port of this car and provide various modification options to it, like adding keys, read EEPROM data, module synchronization, as well as diagnosis functions and multiple special functions. IK618 key programmer also comes along with KC100 transponder generator and EEPROM adapter, allows you to generate dealer keys, read key remote frequency, and modify EEPROM data on bench.

TABLET

The main unit of the IK618 is the tablet, which can be directly connected to the tablet and the car with the test cable.

FRONT VIEW OF TABLET

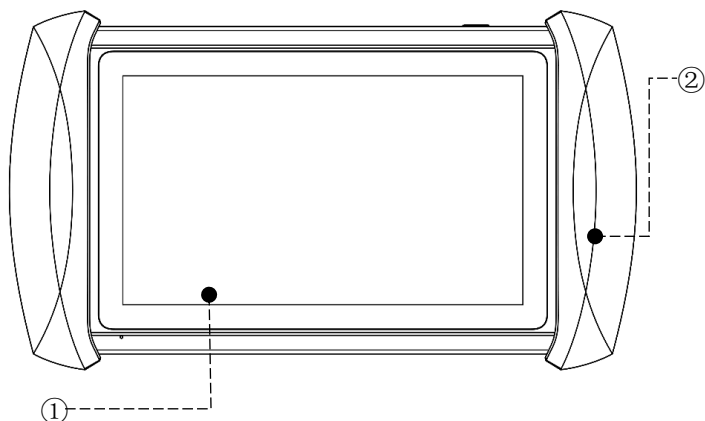

- ① **Grip:** this part is used to hold the device by hand

- ② **Touch Screen:** Shows the info from the device and allows you to operate the device.

BACK VIEW OF TABLET

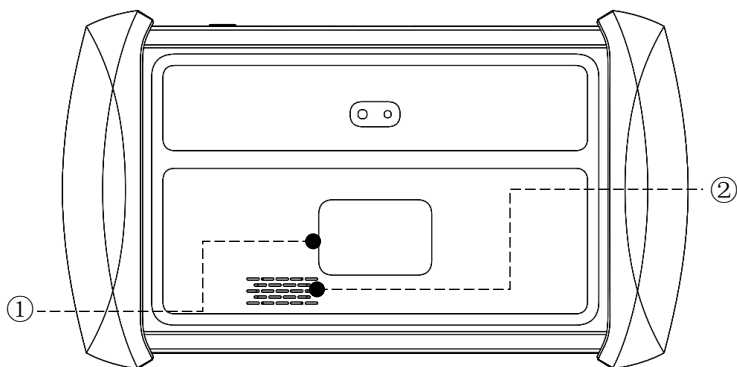

- ① **Nameplate:** Shows basic info for the device like serial number, safety info, etc.
- ② **Loudspeaker:** Use as sound/voice output.

HOST PORTS

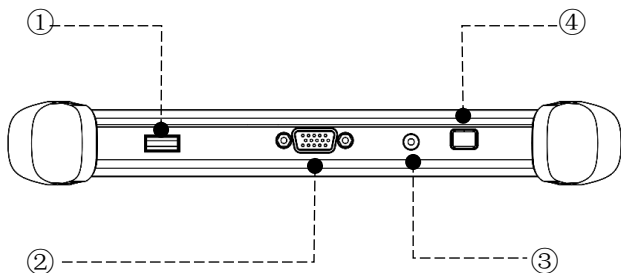

- ① **USB Port:** Used to transfer data via PC. Also used to connect with KC100 and other accessories.
- ② **DB15 Port:** This port is used to connect to the main test cable to connect with cars or EEPROM Adapter.
- ③ **DC charging port:** This port is used to charge the device.
- ④ **Power Button:** Long press to power on or off. When the device is on, short press the button to shut down the screen.

ACCESSORIES

KC100 TRANSPONDER GENERATOR

KC100 is a transponder generator that is used to generate dealer key for Volkswagen/Audi/BMW/Fiat/Renault and more models. It can also be used to generate emulated keys, write transponder chips and read remote frequency. KC100 has to be used with IK618.

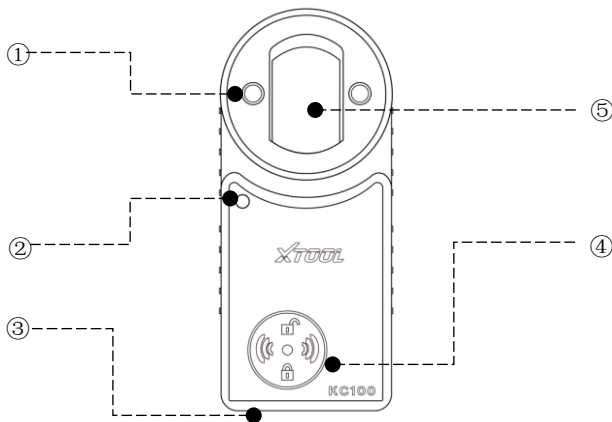

- ① **Key slot:** Insert key into this slot to program keys.
- ② **Transponder Slot:** Insert key chip into this slot to program transponder chips directly.
- ③ **Status Light:** Lights up to show the status of the programmer. Red: KC100 is now power on. Violet: KC100 is now communicating to the device.

- ④ **Frequency detection area:** Put the key here to test remote frequency.
- ⑤ **Mini USB port:** Connects to the device.

EEPROM ADAPTER

EEPROM Adapter allows you to read and write the data from the EEPROM chip of the immobilizer module, dashboard and other modules.

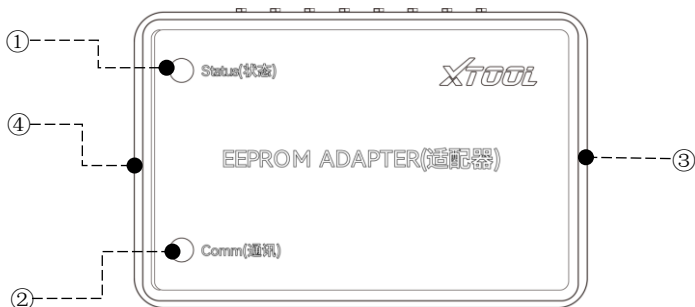

- ① **Status Light:** Shows status of the EEPROM adapter. Will turn red when it's connected to any power supply.
- ② **Comm Light:** Shows communication status of the EEPROM adapter. The light will flash when communicating to the tablet.
- ③ **14-Pin Port:** Used to connect the EEPROM board onto the adapter.
- ④ **DB15 Port:** Used to connect the adapter to the tablet.

TECHNICAL SPECIFICATIONS

Item	Description
Operating System	Android
Processor	2G
Memory	32GB
Display	7.0-inch touch screen with 1024 × 600 resolution
Connectivity	<ul style="list-style-type: none"> ● USB ● Wi-Fi

	● Wired
Sensors	Gravity sensor, light sensor
Auto Input/Output	Microphone, dual speakers
Power and Battery	5000mAh, 3.65V lithium-polymer battery
Power Voltage	5V
Power Consumption	8W
Operating Temperature	-20 to 60°C(-4 to 140°F)
Storage Temperature	-40 to 70°C(-40 to 158°F)
Humidity	<90%
Dimension (L*W*H)	249*142*33.5mm

PACKAGE LIST

Category	No.	Name	QTY
Connector & Cables	1	VGA to DB15 Male Main Cable	1
	2	OBD2-16 Connector	1
	3	USB3.0 Cable	1
	4	Mini USB to USB-C Cable	1
Devices	1	P710 Tablet	1
	2	KC100 Programmer	1
	3	EEPROM Adapter	1
Chargers	1	Power adapter for Tablet	1
	2	US scale Charger	1
	3	EU scale Charger	1
Accessories	1	EEPROM PCBA	2
	2	Color Carton	1
	3	Packing List	1
	4	Tool Carton	1
	5	Tool Case	1
	6	User Manual	1

2 GETTING STARTED

ACTIVATION

After first-time users press and hold the power button to turn on the system, the system will automatically enter the guide process and request to select the language for the operating system.

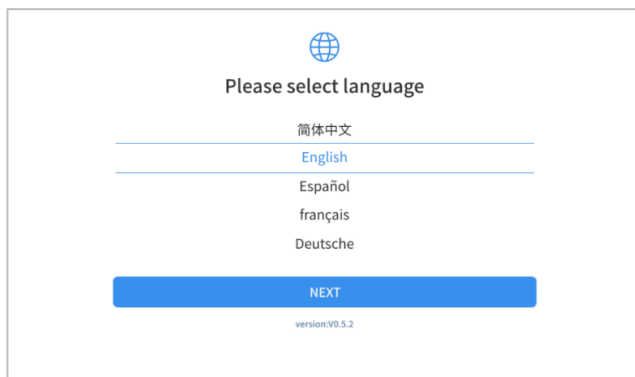

After setting the system language, you will enter the activation page, as shown in the figure below. You can also click the "Trial" button in the upper right corner to try it out before activation.

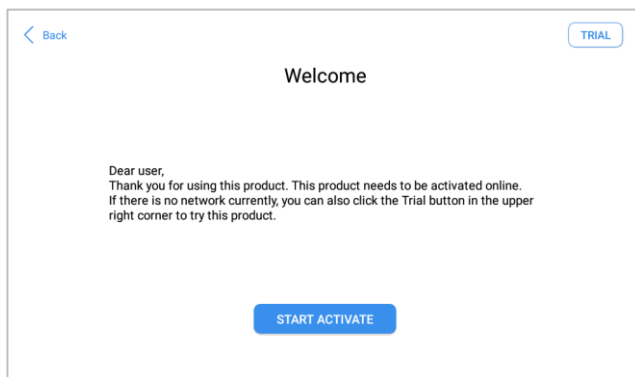

Click **Start Activate** to enter the activation page, as shown below:

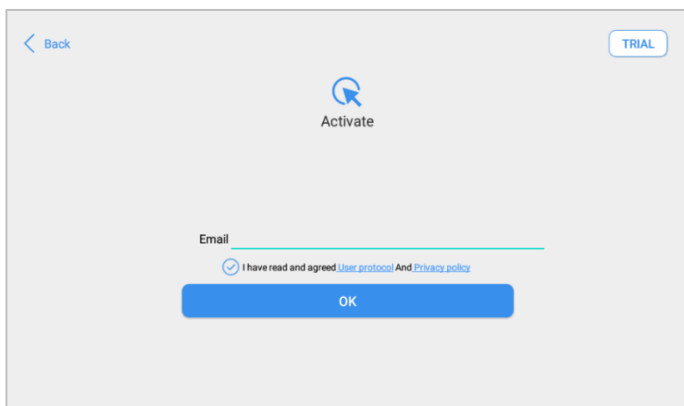

A pop-up window showing **Activation Success** indicates that you have completed the first boot setup, click **OK** to enter the diagnostic system and start using the device.

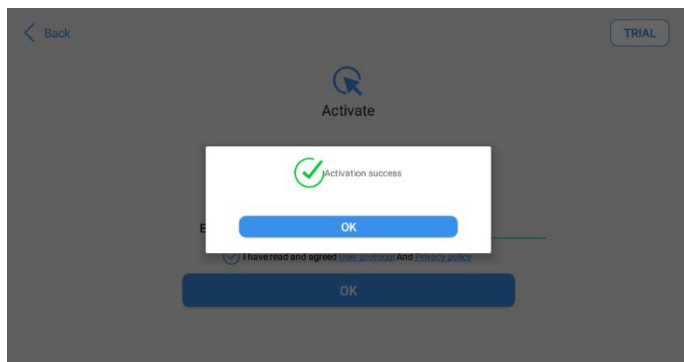

① After factory reset the device, you will need to reactivate it again. Please note that the subscription will not be refreshed after reset.



MAIN INTERFACE

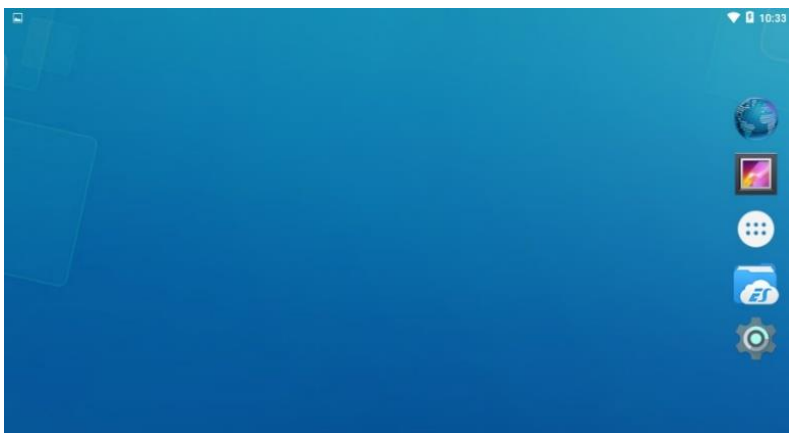

OPERATION SYSTEM

As shown in the figure below, this interface is the main page of the operating system of the device. You can also return to this interface at any time by clicking **【○】** on the bottom navigation bar.



The icons on the right, from top to bottom, are browser, photo album, application square, file manager, system settings, as shown below:

Items	Descriptions
	Browser
	Album
	Application Menu

	File Explorer
	Settings for Android System
	IK618 Key Programming System

- a) **Browser:** Click on the browser icon to enter the browser to view the official website of XTOOL or search for other information.
- b) **Gallery:** Click the **Gallery** icon to enter the album to quickly view the pictures or screenshots stored in the device. You can select the picture you need, click the share button on the upper right, and send the picture to your mobile phone or PC via Bluetooth or USB connection
- c) **Application Menu:** This function is suitable for power balance after replacing and repairing the cylinder. You can remove or add apps here.
- d) **ES File Explorer:** You can manage APP, music, files, pictures, etc. in the device in this function, and you can also use Local/Home/Cleaner to clean up files.
- e) **Android Settings:** Allows you to check and change the settings of the Android system, including network, battery status, language, device info and factory reset.

IK618 APP MENU

Once activated, you will automatically enter the IK618 app with the following main screen. Tap on the Diagnostic application button on the menu, the main interface will be shown as below:



The main screen contains **Function Buttons** and **Navigation Buttons**. The touch screen navigation is menu-driven, and you can quickly access functions by clicking on the option title and answering the dialogue window. A detailed description of the menu structure can be found in the next section **Function Buttons**.

FUNCTION BUTTONS





The following table briefly describes each function button.





Menu	Description
Key Pogramming	Enter immobilizer menu
Auto Scan	Enter diagnosis menu
Special Function	Enter special function menu
Remote Control	Enter TeamViewer for remote support

Updates	Update the software through Internet
Setting	Enter settings menu to change settings in the app
More	Contain more options, like XTOOL, where you can check Xtool official website for full support list, check user manual and other details
Reports	Check the diagnosis report that recorded in your device, print as PDF files, or share to other devices
Tech Support	Shows contact information with XTOOL Tech Support

NAVIGATION BUTTONS

Instructions for operating the navigation bar buttons at the bottom of the screen, as described in the table below:

Items	Descriptions
	Press for screenshot
	Decrease volume
	Back to the previous interface
	Shows recently used applications
	Back to the main interface of the Android system

	Increase volume
	Showing the Bluetooth states
	Click this button to return to the diagnostic vehicle interface
	Press for screen recording

NOTIFICATION BAR

Slide down to open the notification bar. You can adjust the brightness of the screen when needed, and you can also connect Wi-Fi and so on.

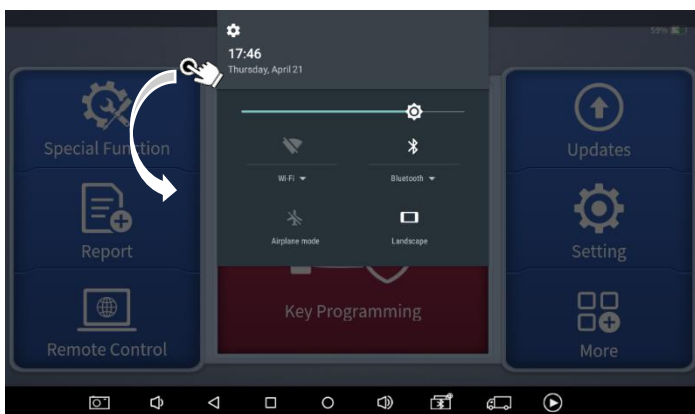

3 UPDATE

After activating the device, please update the software in "**Update**" first. The device will pull all currently supported software packages, and you can download them as needed. ALL software updates directly via the Internet. To access the update application, open the Diagnostic application and click UPDATE, shown as below:

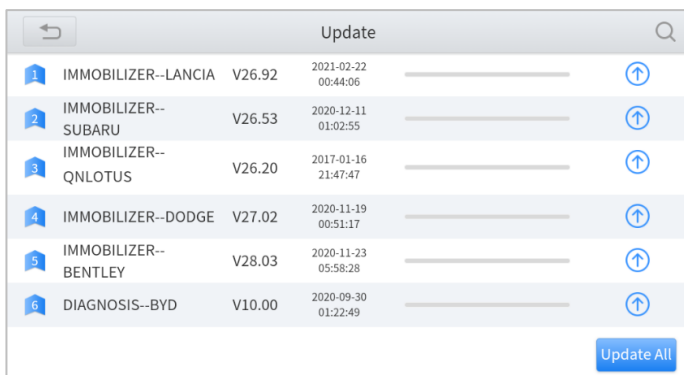

① After contacting your dealer to change the language configuration, please download all the software packages on the device again.

① IK618 has a two-year free subscription when activated. When you click "update" and it shows "your device is now out of subscription", please contact your dealer.

4 KEY PROGRAMMING

The key programming software inside IK618 app can get access to the immobilizer system inside the vehicles and supports multiple functions like key programming, generate dealer key, all key lost, immobilizer reset or changing, EEPROM chip coding and much more.

① For different manufacturers, the menu inside each software and the supported functions will be different. We suggest checking the support list inside our official software first or ask XTOOL aftersales services if you have any questions.

VEHICLE CONNECTION

To start the key programming process, the VCI communication box should establish communication with the vehicle, and Bluetooth should be connected between the tablet and the VCI box. Please follow the steps below.

1. Turn on the tablet.
2. Connect the vehicle to the tablet following the diagram below. Usually, the OBD port is normally located under the dashboard, inside driver's footwell.
3. Click into the menus to perform the functions.

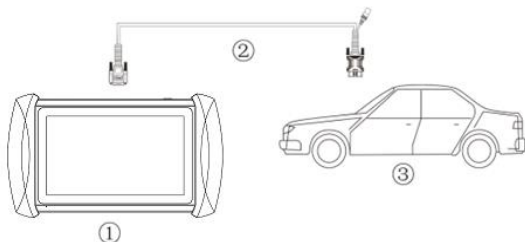

① The main cable will charge the tablet when connecting to the vehicle.

① Some older vehicles are not using the OBD2-16 port, please make sure you're using the correct connector. If necessary, contact your dealer if you need other connectors.

CONNECT TO KC100

In order to connect to KC100, please follow the steps below.

1. Turn on the tablet.
2. Find the cable that connects Mini USB and USB 3.0.
3. Connect the Mini USB socket into the bottom of KC100 and connect the USB 3.0 socket into the IK618.
4. When the light turns on, you can perform the functions.

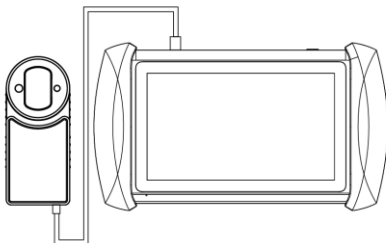

CONNECT TO EEPROM ADAPTER

In order to read EEPROM chips using the EEPROM Adapter, please follow the steps below.

1. Unsolder the EEPROM chip from the module.
2. Install (or solder) it onto the EEPROM board according to the chip type.
 - ① There are 3 rows on the board and each row represents a type of EEPROM chip, so please recognize the chip you are using first and install it onto the right side of the board.
3. Connect the board to the 14-pin port of the EEPROM Adapter.
4. Connect the other side of the adapter to the main cable and connect the cable to the device.
 - ① If the OBD2 connector is installed on the main cable, you need to take it out first in order to connect to the EEPROM Adapter.

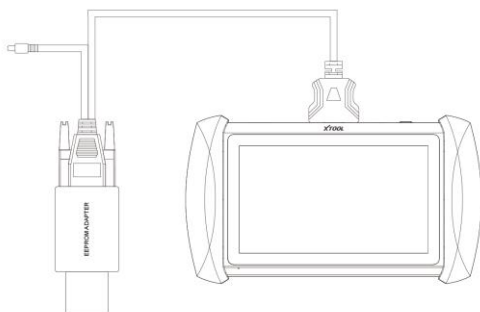

IMMOBILIZER MENU

Click “Key Programming” icon on the main screen and get into the immobilizer menu. Choose the brand of the vehicle to start the programming process. You can also click the search icon on the top-right corner of the screen and find the brand you need.

① If you need to check if your car is supported, you can check the support list from the official website.



IMMOBILIZER FUNCTIONS

Normally the key programming software supports these functions:

- Check number of keys
- Read PIN code/pin code calculation
- Add key
- Generate dealer key
- All key lost

And more...

Some examples will be provided in this manual to help you understand the process.

① For different models with different immobilizer modules, the key programming process will be completely different. Because of that we can only give some examples about how to do that. Most of the process could be done by following the instructions on the screen. But if you are not sure how to do that, please check the tutorials.

READ PIN CODE/PIN CODE CALCULATION

Let's take Nissan software for example. Click "Diagnosis – Services - Immobilization – Nissan – Pin Calculator" to enter the system, then this menu below will show up.

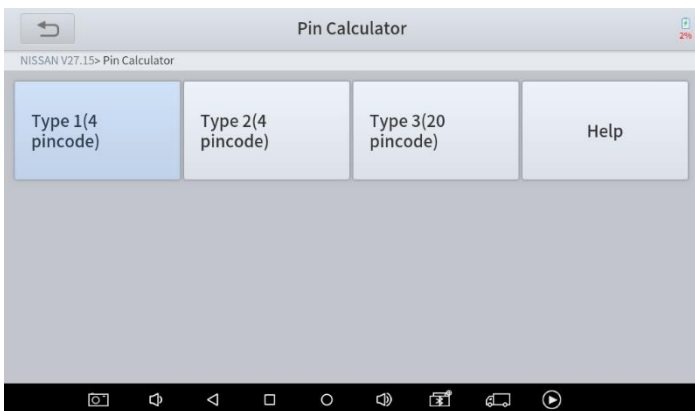

Please choose the type of your vehicle. If you have any questions, please click “Help” for more details.

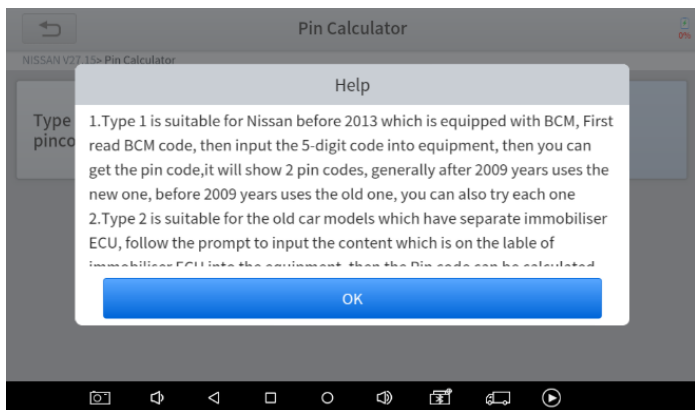

Here we choose “Type 1”, then insert the 5-digit BCM code.

① The BCM for Nissan vehicles may be found under the steering wheel, behind the glove box, behind the passenger/driver side kick panel and behind dash cluster - depending on the model of vehicle.

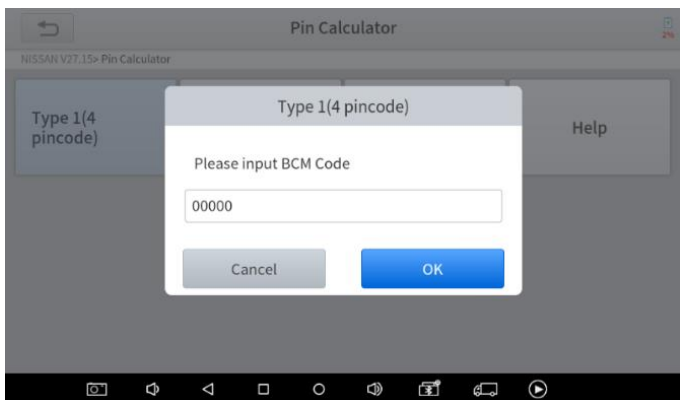

After you inserted the code, the results will show up.

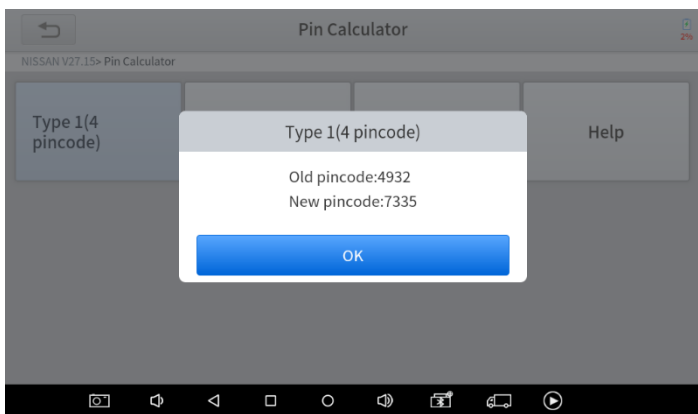

① Quick Tip: If you have trouble working on Nissans, please change the language into English, check the updates and see if there is a "NISSAN PIN DATA". Usually download it will solve the problem.

CHECK NUMBER OF KEYS

Here we take a 2020 Honda Accord with smart key as an example. Click “Immobilization – Honda – By vehicle – Accord – Smart key – Button type” to enter the system, then this menu will show up.

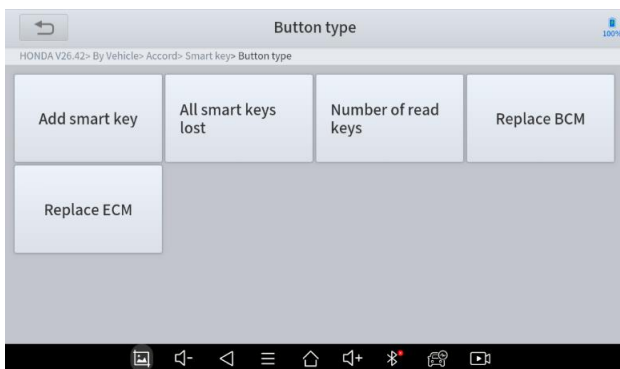

Click “Number of read keys” and it will show the number of the keys that are registered to the vehicle.

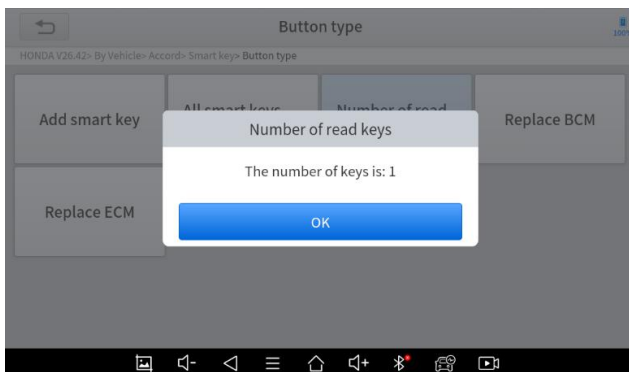

ADD KEYS

Still take the 2020 Honda Accord as an example. Click “Add smart key” menu, then check the notice from the screen.

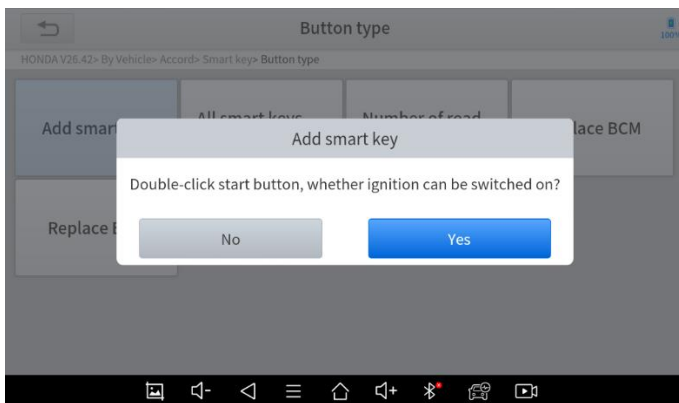

Because this vehicle is paired with smart keys, we need to take all the keys out from the vehicle before programming, then put the original key inside the car.

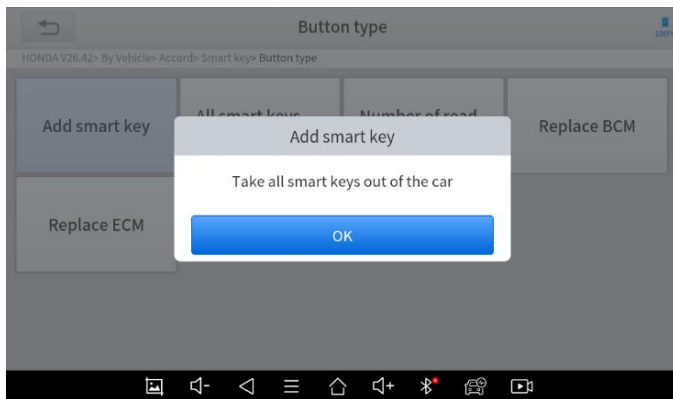

Now the system will configure the data and after it's done, take the smart key out from the car first.

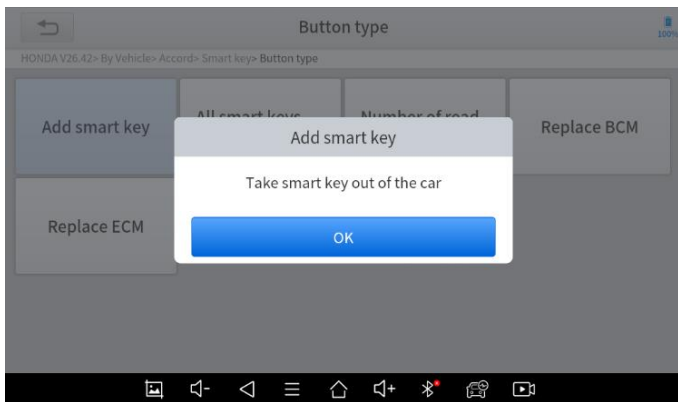

Then take a new key and put it into the car.

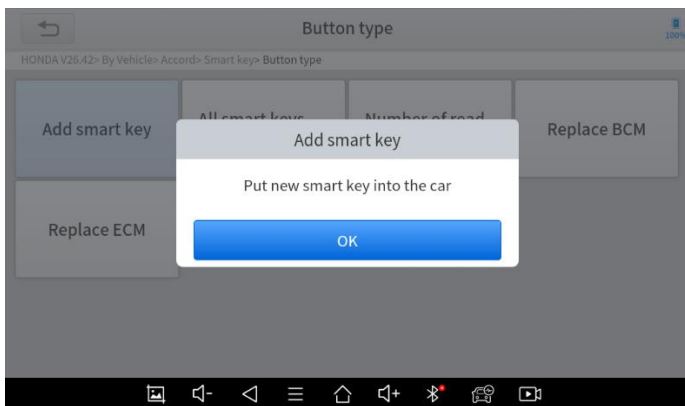

Then it will start processing. You need to follow the instructions and turn the ignition on and off for several times when processing. Then the system will pop up a notice, telling you to check if the security light on the dashboard goes off.

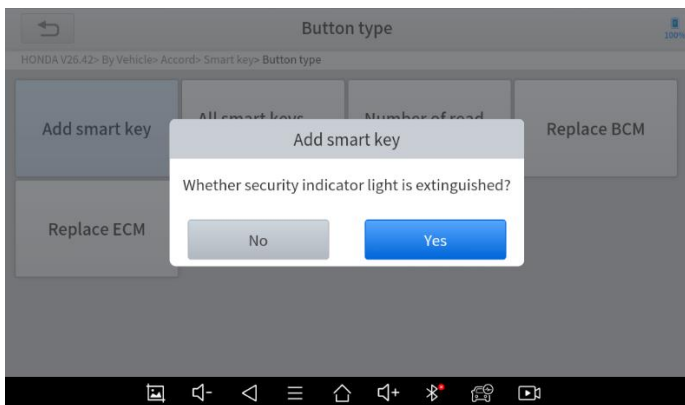

If it really goes off, press “Yes”, wait for a while, and the process will be done.

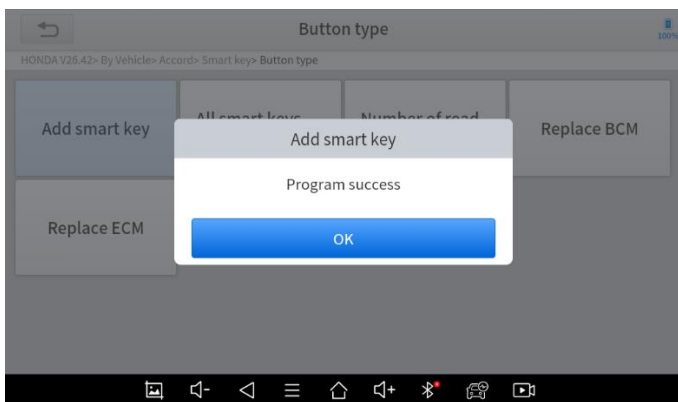

ALL KEY LOST

Still take the 2020 Honda Accord as an example. Click “All smart keys lost” menu and this notice will show up. Follow the instructions and take all the keys out from the car, then click “OK” to continue.

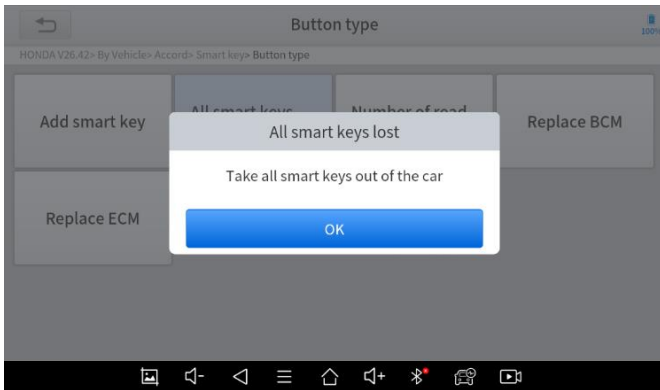

Then put one of the new keys inside the car.

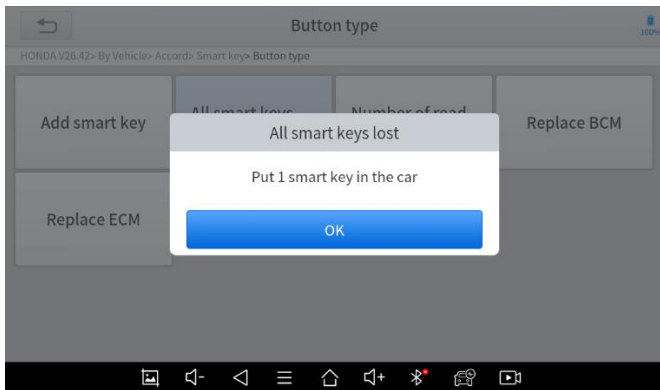

As before it will check if the ignition could be turned on when you double-clicked the start button. Since we don't have a programmed key in an all-key-lost situation, we click "No" here.

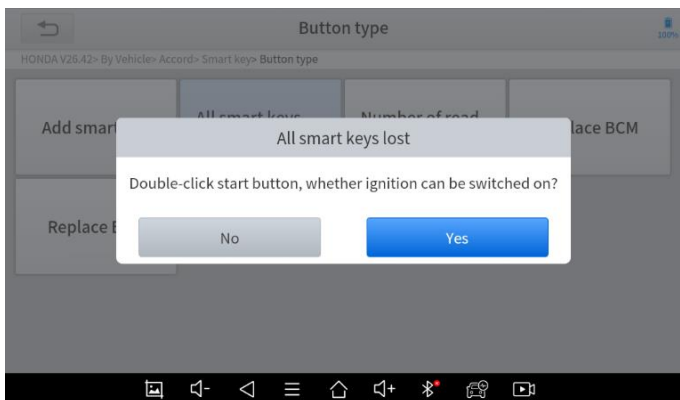

Then press and hold the start button, and press “OK” to continue.

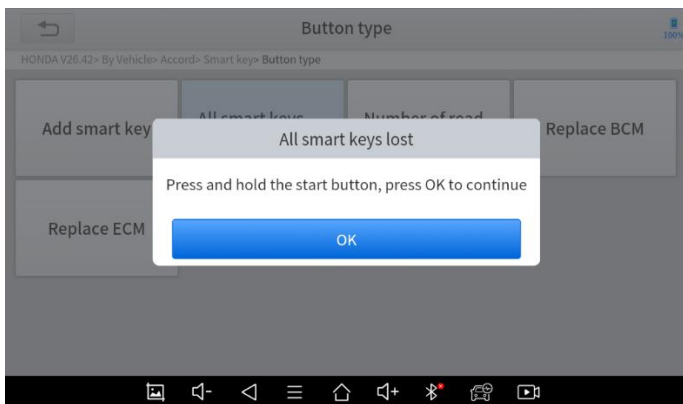

After that, please check the ignition status. Same as before, we click “No” here.

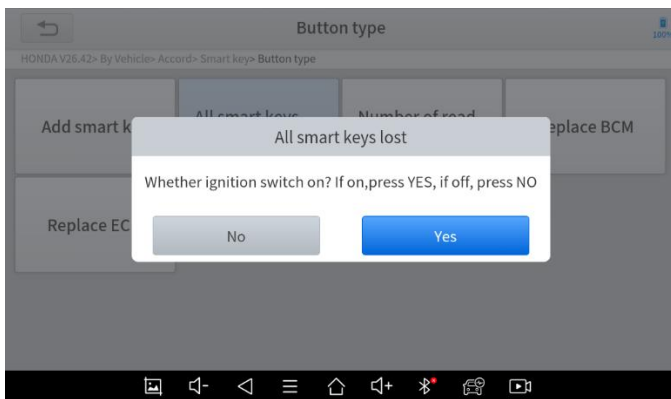

Then it will check the model. Because this is a 2020 model, we select “Yes” here.

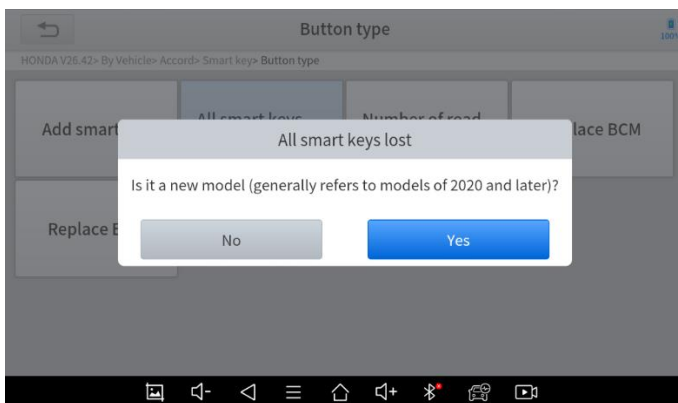

Now input the number of keys you're going to program; we choose 1 here.

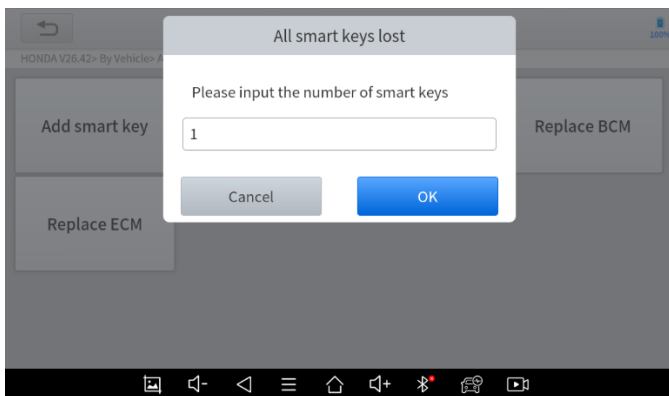

Like the “add key” process, it needs you to turn the ignition on and off for several times. After that, check security light of the dashboard.

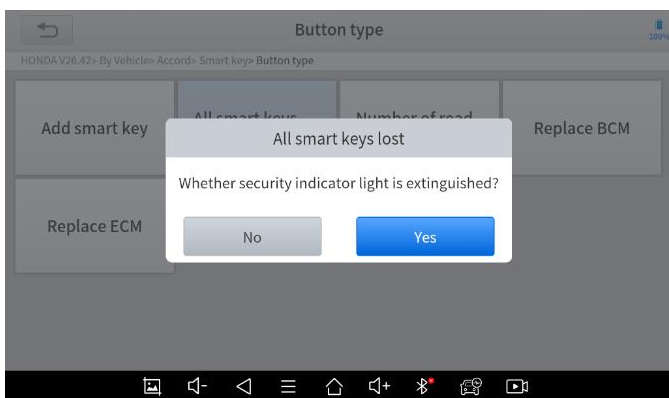

Then the instructions will tell you to turn the ignition on and off again. It will show “Program success” when it’s done.

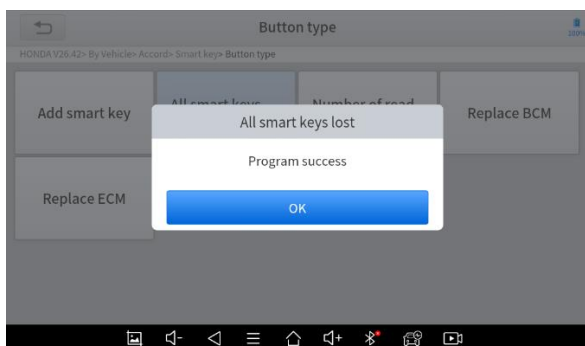

① We suggest checking all the keys every time after you programmed the key.

5 DIAGNOSTIC

The diagnostic application can read ECU information, read and clear DTC and check live data and freeze frames. The Diagnostic application can access the electronic control unit (ECU) of various vehicle control systems, including the engine, transmission, anti-lock braking system (ABS), airbag system (SRS), and perform kinds of actuation tests.

① Please make sure all the cables are connected tightly; The vehicle's DLC is not always located under the dash; for the location of the DLC, please refer to the vehicle's user manual.

DIAGNOSTICS

After the tablet device is properly connected to the vehicle, you could start the vehicle diagnosis.

VEHICLE SELECTION

The IK618 supports the following 3 ways to access the smart diagnostics system.

- **AUTO SCAN**
- **MANUAL INPUT**
- **SELECT VEHICLE BY AREA**

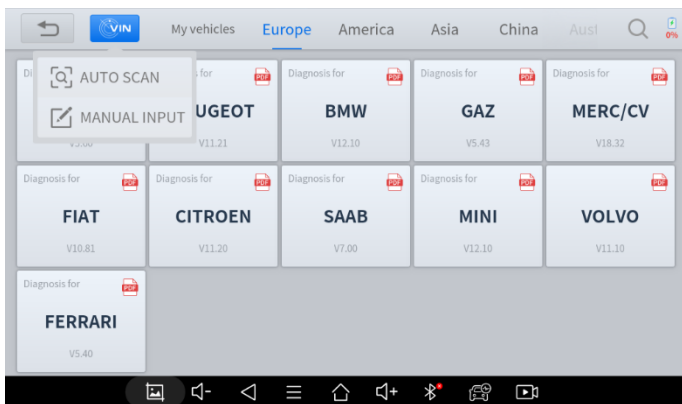

Click the VIN button in the upper left corner, you can choose to enter the vehicle diagnosis through the first 2 ways of **AUTO SCAN/ MANUAL ENTER**.

AUTO SCAN: It supports automatic reading of vehicle VIN code. You also can tap on the button “AUTO SCAN” on the diagnosis system entrance to use this function. Please make sure that the car and the device are well connected before using this function.

MANUAL ENTER: It supports manual input of car VIN code. When entering the VIN code manually, make sure that the 17 characters entered are correct to avoid reading failure.

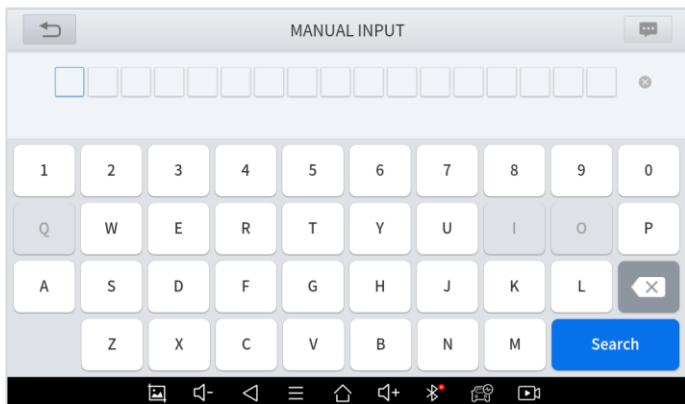

- **SELECT VEHICLE BY AREA**

In addition to the above 3 methods, you can also choose a car brand according to the region. You can select the vehicle model that needs to be diagnosed according to the area, as shown below:

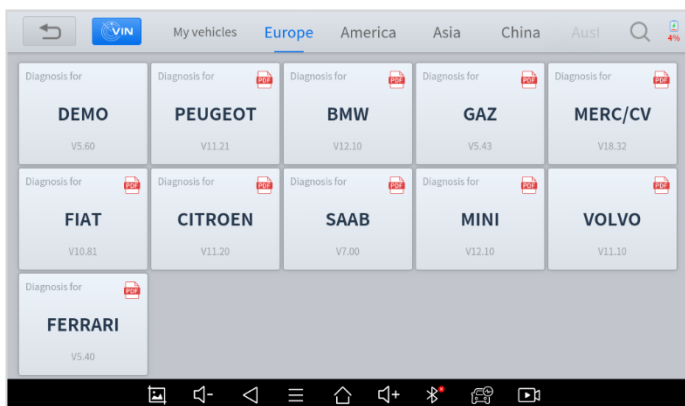

OBD- II supports reading the related fault codes of PCM; DEMO, a demonstration program; Click this button to experience and learn the operation process of the diagnostic function

Some models provide multiple entry methods in the sub-menu, including:

- Automatic Detection
- Manual Selection
- System Selection

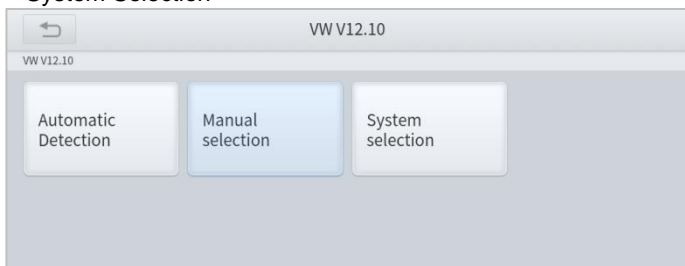

Automatic Detection will automatically identify the vehicle's VIN code, and then read the information of your target diagnostic object. If you choose "**Manual selection**", then you can continue to select the vehicle brand, year, and model of the vehicle in the sub-menu to diagnosis the vehicle. Enter "**System Selection**", you can also diagnose the vehicle according to the system according to your needs after selecting the model.

DIAGNOSIS FUNCTIONS

Diagnostics functions supported by IK618 Smart Diagnostics System are as below::

- **Read ECU Information**
- **Read/Clear Trouble Code**
- **Read Live Data**
- **Actuation Test (Bi-Directional Control)**
- **Freeze Frame**



- **READ ECU INFORMATION**

This function is to read ECU version information, which is the equivalent of "**System Identification**" or "**System information**" in some electronic control systems, all mean to read ECU related software and hardware versions, models and production date of diesel engine, part number, etc. It is convenient for us to make a record in the maintenance process, and it also makes data feedback and management easier.

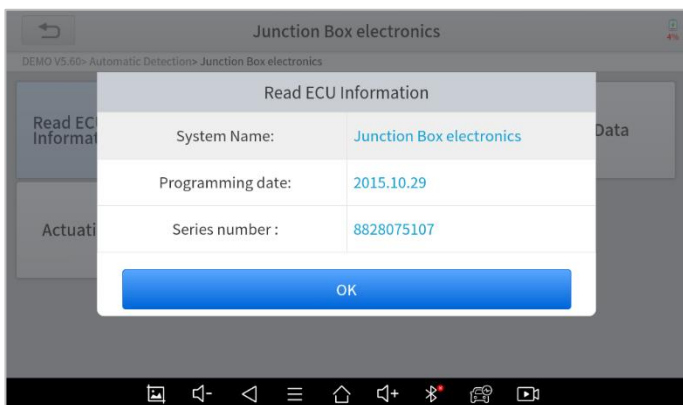

- **READ TROUBLE CODE**

NO.	Trouble Code	Trouble Code Descriptions	Trouble Code status
1	8020B8	Tank fill-level sensor, left: short circuit to positive or open circuit	
2	8020B9	Tank fill-level sensor, left: signal invalid	

※NOTE: In the process of diagnosis, if the device shows “**System is OK**” or “**No Trouble Code**”, it means there is no related trouble code stored in ECU or some troubles are not under the control of ECU, most of these troubles are mechanical system troubles or executive circuit troubles, it is also possible that signal of the sensor may bias within limits, which can be judged in Live Data.

● CLEAR TROUBLE CODE

It allows clearing current and historical trouble codes memory in ECU, under the premise that all the troubles are eliminated.

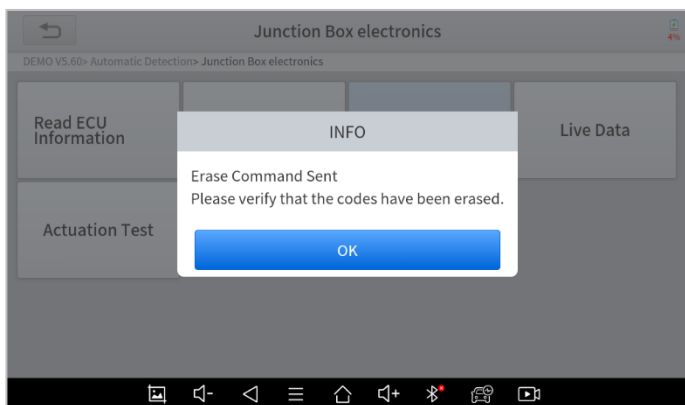

The trouble codes can't be erased without eliminating all the troubles, which will cause the diagnostic tool to always read the trouble code because the code will always be saved in ECU. Suggestion: users should better not clear trouble codes, we need to record the trouble details after reading the code, which is provided as a reference for maintenance. After dealing with troubles, there will be no trouble code when we re-read.

● READ LIVE DATA

That is to read the parameters of the running engine, such as oil pressure, temperature, engine speed, fuel oil temperature, coolant temperature, intake air temperature, etc. Based on these parameters, we can judge directly where the problem lies, which helps to narrow the scope of maintenance. For some vehicles, during their actual operation, the problems such as performance characteristics offset, sensitivity reduction, can be judged in live data.

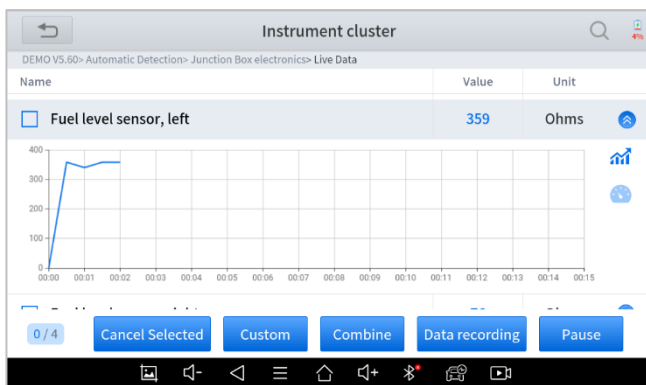
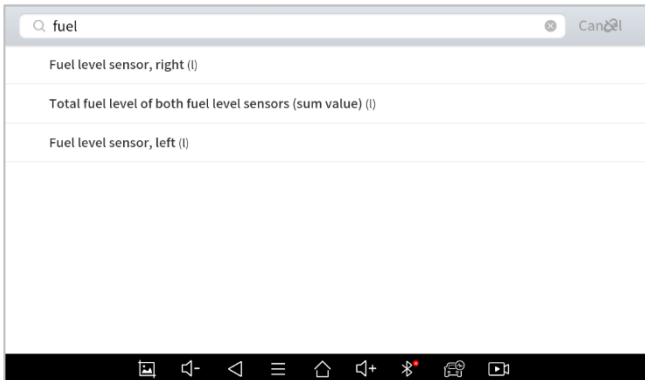
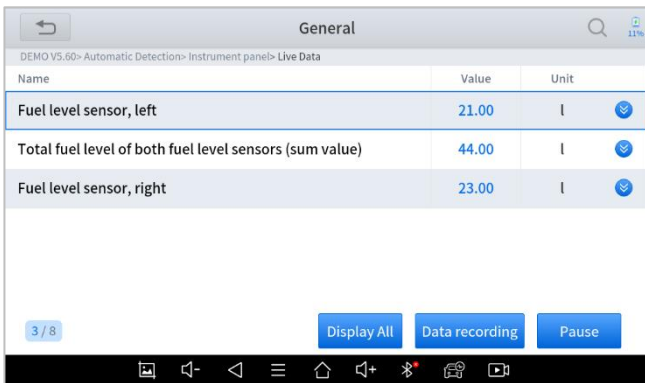

Figure 4-11 Sample of PIDs List

Click the magnifying glass on the top right, you can search for related PIDs based on keywords



- **Custom**



Support to show the selected PIDs. Click **Display All**, back to the page which display all PIDs

- **Combine**

Support to select multiple PIDs and click **Combine** to make different graphs into one chart.

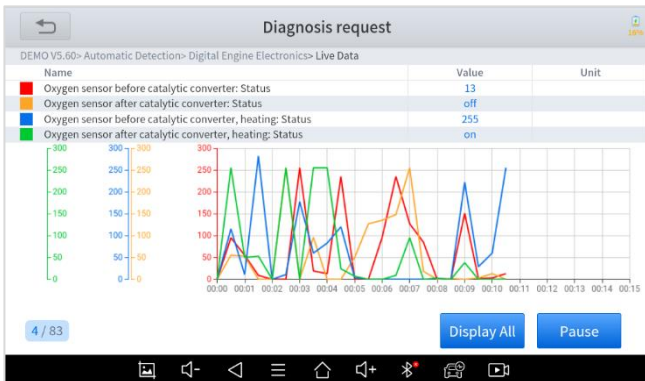

- **Data recording**

Supports recording the current data value in the form of text, you can view the recorded files in **Reports->Data Replay**.

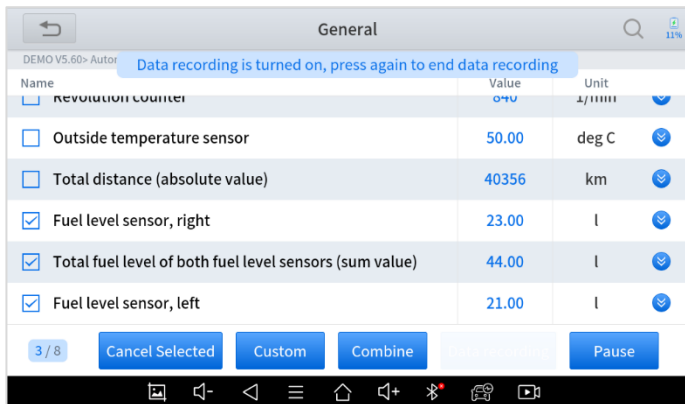

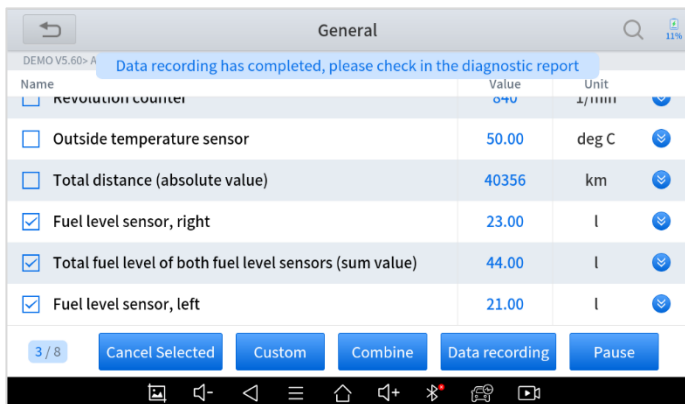

- **Pause**

Click this button to pause the timeline

- **FREEZE FRAME**

When the signal of the sensor is abnormal, the ECU will save the data at that moment of failure to form a freeze-frame. It is usually used to analyze the reasons that may lead to car failures.

The living data items supported by vehicles of different brands are not the same, so the freeze frames displayed when diagnosing vehicles of different brands may also be different. Some vehicles may not have the option of a freeze-frame which means that the model does not support this function.

Take **Renault Duster ii ph** as an example, after selecting the system to enter the lower freeze frame menu, the device will list all the fault codes under the system.

Users can click on a fault code, such as **DF1068** to view the freeze frame recorded by the car when the fault code occurs, including context when the fault appeared, and current context and additional data.

Read trouble code

RENAULT V9.93> Automatic Detection> Duster ii ph> System Selection> Injection

DF1068	Refrigerant pressure sensor voltage	Current
DF887	Accelerator pedal position Fault on gangs 1 and 2 of the pedal potentiometer.	Current
DF974	Pedal potentiometer circuit track 1 Signal outside lower limit Pedal potentiometer	Current

Read freeze frame

DF1068

RENAULT V9.93> Automatic Detection> Duster ii ph> System Selection> Injection> DF1068

Context when fault appeared	Current context	Additional data
-----------------------------	-----------------	-----------------

Context when fault appeared: record the live data when fault appeared to help the user to know the vehicle status. **Some vehicles don't support this function; users will get a prompt when they click the menu.*

Current context: Displays the current live data stream associated with the DTC

NO.	Name	Value	Unit
1	Current context:		
2	Water temperature	-40.0	deg C
3	Computer supply voltage	11.97	V
4	Engine speed	0	rpm
5	Vehicle speed	0.00	km/h
6	Engine torque	0.00	nm
7	Refrigerant pressure	34	bar
8	Refrigerant fluid sensor voltage	-322.68	V

Additional data: record other data related to the fault

NO.	Name	Value	Unit
1	Additional data:		
2	Mileage since fault last disappeared		km
3	Mileage since last appearance of fault		km
4	Number of occurrences of fault		
5	Distance when fault first occurred		km
6	Distance travelled with fault present		km

6 SPECIAL FUNCTIONS

The IK618 Smart Diagnostic System supports 25 commonly used special reset functions, allowing you to quickly access your vehicle system for various scheduled services, maintenance, and reset performance, eliminating the need to reset after resolving common problems. This user manual lists some of the commonly used special reset services for your reference. The special functions interface is shown as below:

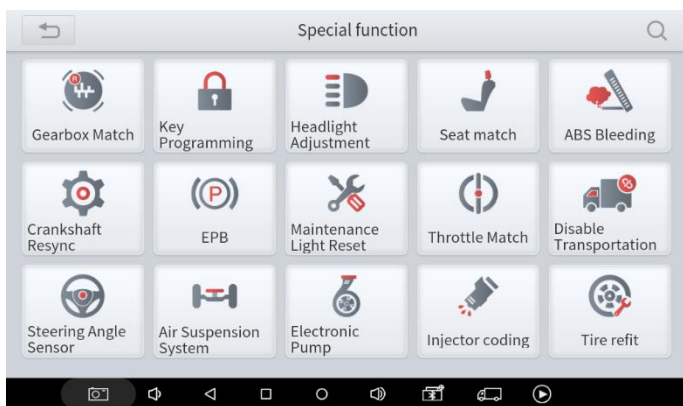

5.1 OIL RESET

Reset the Engine Oil Life System, which calculates the optimum oil life change interval based on the vehicle's driving conditions and climate. The oil life reminder must be reset each time the oil is changed so that the system can calculate when the next oil change is required.

This function can be performed in the following cases:

- If the service lamp is on, you must provide service for the car. After service, you need to reset the driving mileage or driving time so that the service lamp turns off and the system enables the new service

- cycle.
- After changing engine oil or electric appliances that monitor oil life, you need to reset the service lamp.

The operation guidelines of the Oil Reset function are shown as below:

1. Enter the **Oil Reset** menu and choose relevant models according to the vehicle being tested.
2. Follow the instructions displayed and press **OK** after completing the instructions shown.

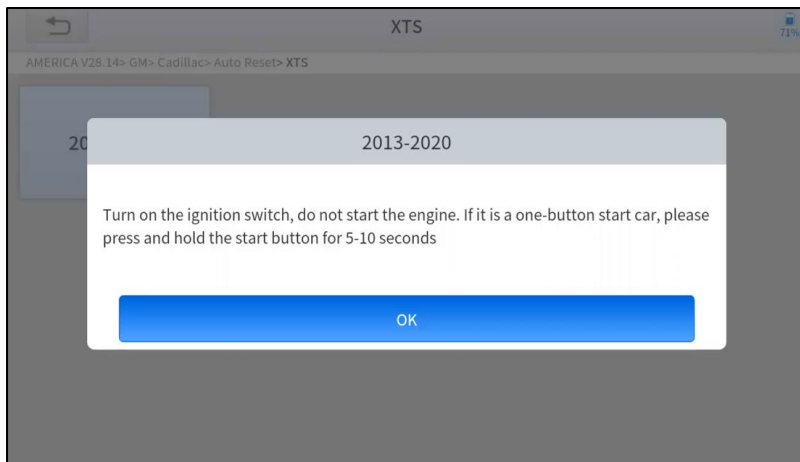

3. Enter **Maintenance mileage reset** menu.
4. Input reasonable value of mileage and press **OK**.

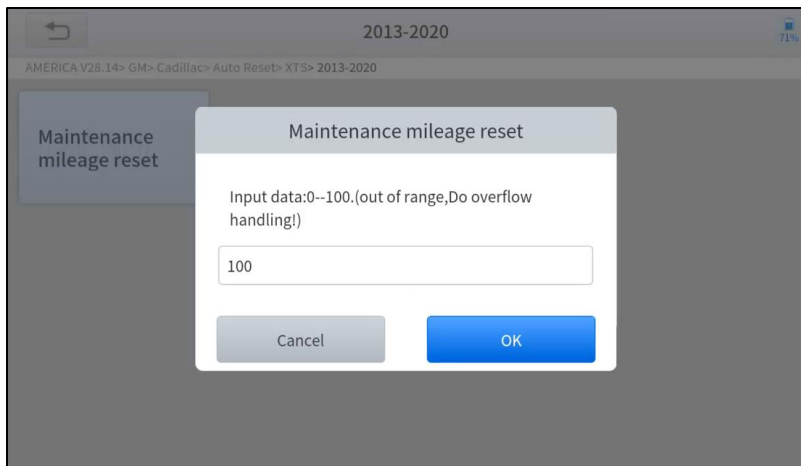

5. Message of 'Reset success' displayed when Oil Reset function has successfully performed.

5.2 EPB

Electronic Parking Brake (EPB) System reset is a popular special function. You can use this function to reset the electronic parking brake system and brake pads, which also supports the brake pad replacement (retraction, release of the brake pump), G-sensor, and body angle calibration. This function has multiple uses and can safely and effectively maintain the electronic brake system. These applications include deactivating and activating brake control systems, assisting in controlling brake fluid, opening and closing brake pads, setting brakes after replacing brake discs or brake pads, etc.

1. If the brake pad wears the brake pad sense line, the brake pad sense line will send a signal to the onboard tablet asking for replacing the brake pad. After replacing the brake pad, you must reset the brake pad. Otherwise, the car alarms.
2. Reset must be performed in the following cases:

- The brake pad and brake pad wear sensor are replaced.
- The brake pad indicator lamp is on.
- The brake pad sensor circuit is short, which is recovered.
- The servo motor is replaced.

The operation guidelines of the EPB function are shown as below:

1. Enter the **EPB** menu and choose relevant models according to the vehicle being tested.
2. Follow the instructions displayed and press **YES** after completing the instructions shown.

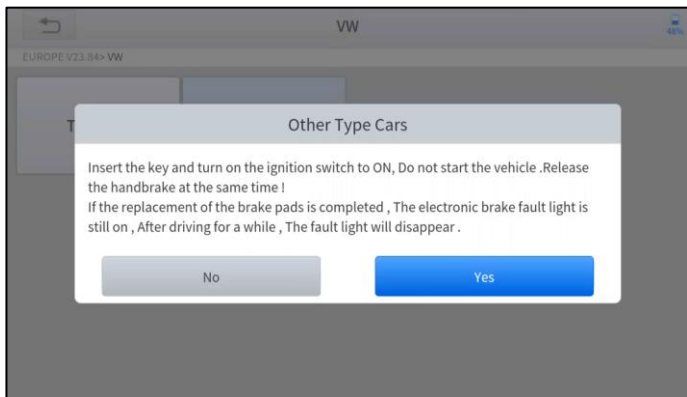

3. Enter the **Enter maintenance mode** menu and release the handbrake brake. And press **OK** after completing the instructions shown.

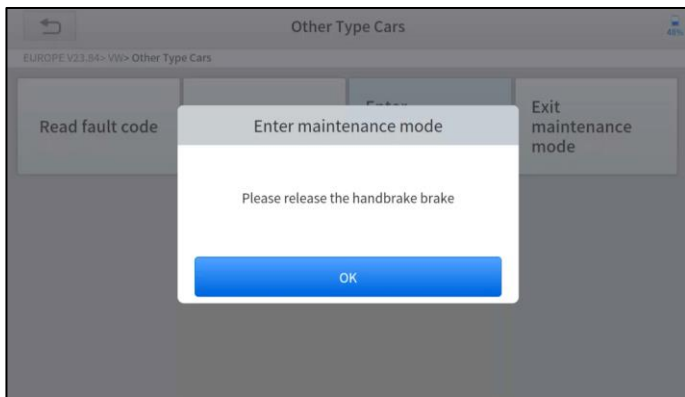

4. Wait until the message of '**Successful operation**' pops up. And press **OK** to exit the menu.
5. Enter the **Exit maintenance mode** menu and wait until the message of "**Successful operation**" pops up.

5.3 SAS

Steering Angle Sensors (SAS) System Calibration permanently stores the current steering wheel position as the straight-ahead position in the SAS EEPROM. Therefore, the front wheels and the steering wheel must be set exactly to the straight-ahead position before calibration. In addition, the VIN is also read from the instrument cluster and stored permanently in the SAS EEPROM. On successful completion of calibration, the SAS fault codes will be automatically cleared.

To reset the steering angle, you need to first find the relative zero point position for the car to drive in a straight line. Taking this position as a reference, the ECU can calculate the accurate angle for left and right steering.

After replacing the steering angle position sensor, replacing steering mechanical parts (such as steering gearbox, steering column, end tie rod, steering knuckle), performing four-wheel alignment, or recovering the car body, you must reset the steering angle.

The operation guidelines of the SAS function are shown as below:

1. Enter the **SAS** menu and choose relevant models according to the vehicle being tested.
2. Enter the **Set steering angle sensor** menu and follow the instructions displayed.

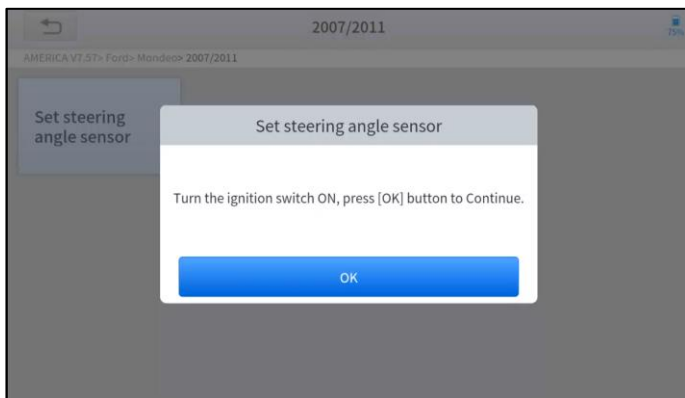

3. Wait until the following instruction is displayed and press **Yes** after completing the instructions shown.

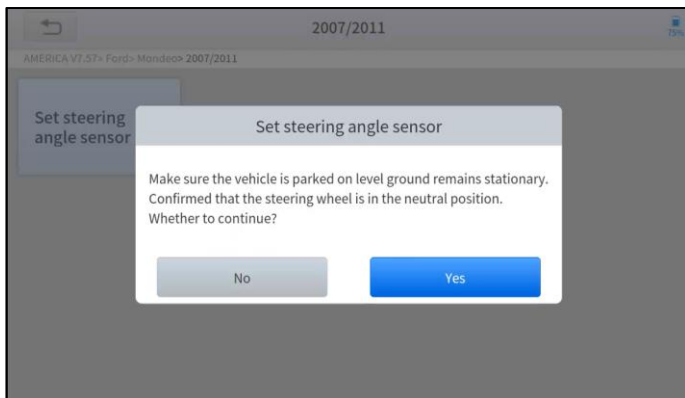

4. Follow the instructions displayed and press **OK** after completing the

instructions shown.

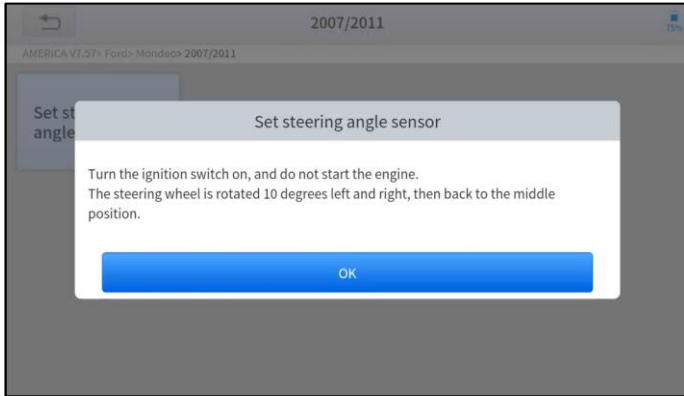

5. Wait until the following instruction is displayed and press **OK** after completing the instructions shown.

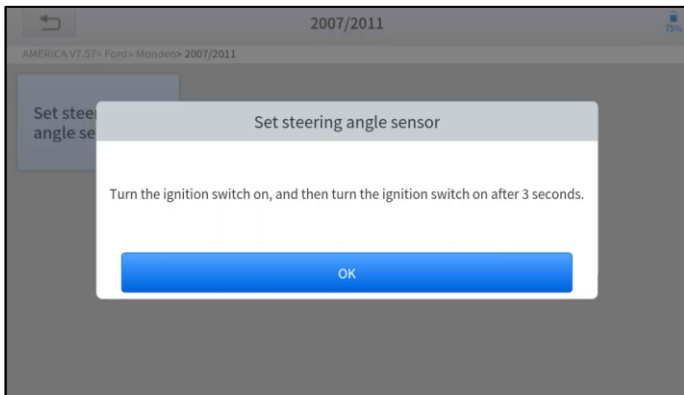

6. Message of '**Function execution is completed**' displayed when SAS function has successfully performed.

5.4 DPF

The Diesel Particle Filter (DPF) function manages DPF regeneration, DPF component replacement teach-in, and DPF teach-in after replacing the engine control module (ECM).

The ECM monitors driving style and selects a suitable time to employ regeneration. Vehicles driven a lot at idling speed and low load will attempt to regenerate earlier than vehicles driven more with higher load and speed. For regeneration to take place, a prolonged high exhaust temperature must be obtained.

In the event of the car being driven in such ways that regeneration is not possible, i.e., frequent short journeys, a diagnostic trouble code will eventually be registered in addition to the DPF light and “Check Engine” indicators displaying. A service regeneration can be requested in the workshop using the diagnostic tool.

DPF regeneration is used to clear PM (Particulate Matter) from the DPF filter through continuous combustion oxidation mode (such as high-temperature heating combustion, fuel additive or catalyst reduce PM ignition combustion) to stabilize the filter performance.

DPF regeneration may be performed in the following cases:

- The exhaust back pressure sensor is replaced.
- The PM trap is removed or replaced.
- The fuel additive nozzle is removed or replaced.
- The catalytic oxidizer is removed or replaced.
- The DPF regeneration MIL is on and maintenance is performed.
- The DPF regeneration control module is replaced.

The operation guidelines of the DPF function are shown as below:

1. Enter the **DPF** menu and choose relevant models according to the vehicle being tested.
2. Enter the **DPF regeneration** menu.
3. Read carefully and complete the **requisites** listed before performing the DPF regeneration function. And press **OK** after completing the instructions shown.

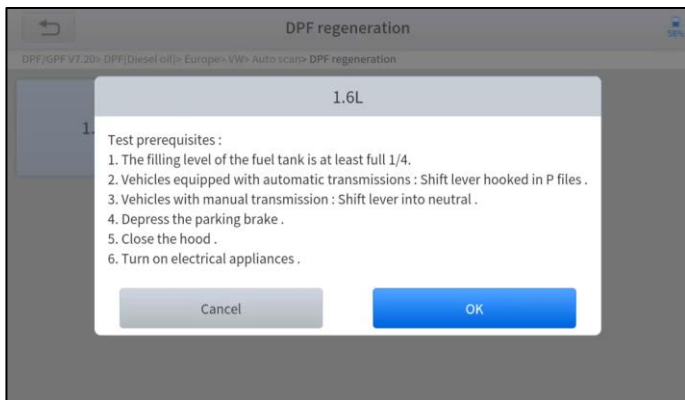

4. Read the fuel tank level and make sure that it fulfills the requirement displayed.
5. Read the carbon deposit load.
6. Choose the drive to warm up and follow the instructions listed below. And press OK after completing the instructions shown.

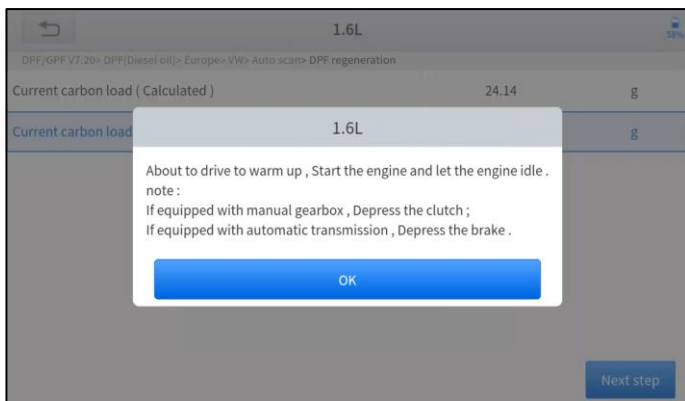

7. Read the note carefully and follow the instructions shown on the screen. And press **OK** after completing the instructions shown.

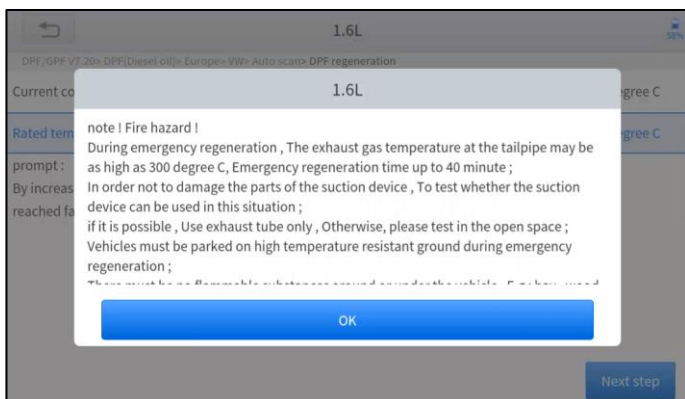

8. Follow the instructions displayed and press **OK** after completing the instructions shown. Please pay attention to the Note.

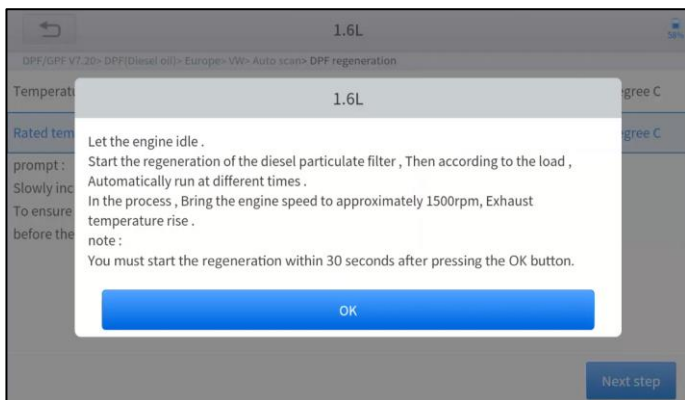

9. Press the **OK** button to start the regeneration.

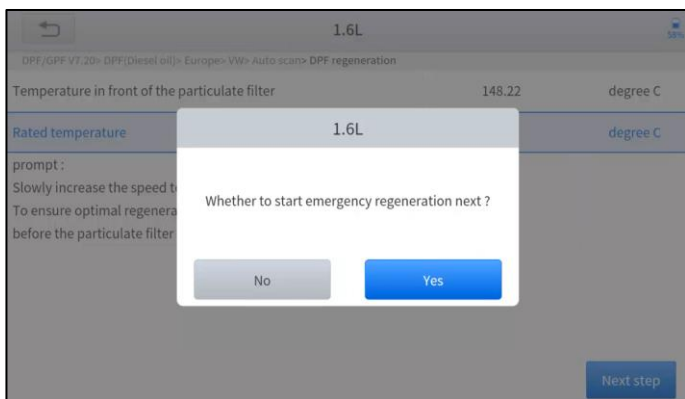

10. Wait for the value of carbon deposit to decrease until a message of 'Emergency regeneration has been **completed**' pops up, this process may take up to 40 minutes.

1.6L

DPF/GPF V7.20> DPF(Diesel oil)> Europe> VW> Auto scan> DPF regeneration

Regeneration duration	0.00	min
Carbon deposit	22.78	g
Rotating speed	781	rpm
Waste temperature upstream of turbocharger	143.41	degree C
Upstream of particulate filter	143.21	degree C
Downstream of particulate filter	112.38	degree C

Next step

11. Wait for **2 minutes** to let the particulate filter cool down.

1.6L		
DPF/GPF V7.20> DPF(Diesel oil)> Europe> VW> Auto scan> DPF regeneration		
Current carbon load (Calculated)	24.14	g
Current carbon load (Measurements)	1.32	g
Let the engine run at idle again 2 Minutes to cool down the hot particulate filter	120	s

drop out

12. Press **drop out** to exit the DPF function.

5.5 BMS RESET

The Battery Management System (BMS) allows the scan tool to evaluate the battery charge state, monitor the close-circuit current, register the battery replacement, and activate the rest state of the vehicle.

This function enables you to perform a resetting operation on the monitoring unit of the vehicle battery, in which the original low battery fault information will be cleared and battery matching will be done.

Battery matching must be performed in the following cases:

- The main battery is replaced. Battery matching must be performed to clear original low battery information and prevent the related control module from detecting false information. If the related control module detects false information, it will invalidate some electric auxiliary functions, such as automatic start & stop function, sunroof without one-key trigger function, power window without automatic function.
- Battery matching is performed to re-match the control module and motoring sensor to detect battery power usage more accurately, which

can avoid an error message displayed on the instrument cluster.

The operation guidelines of the BMS Reset function are shown as below:

1. Enter the **BMS Reset** menu and choose relevant models according to the vehicle being tested.
2. Turn on the ignition switch.
3. Press **OK** to continue the BMS function.
4. Enter **battery capacity** (within the given range) and press **OK** after the input.



5. Enter the **battery manufacturer** and press **OK** after the input.

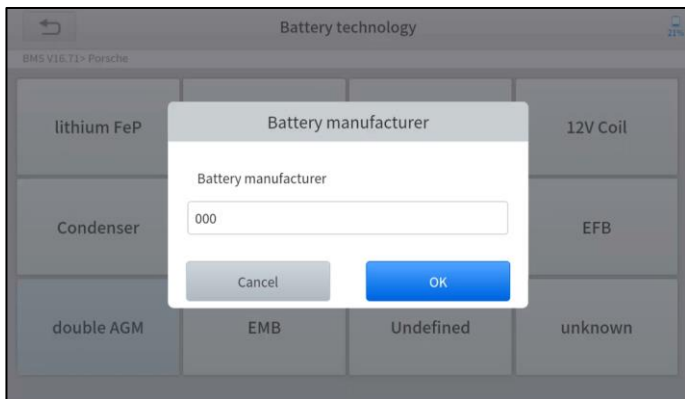

6. Enter the **10-digit battery serial number** and press **OK** after the input.

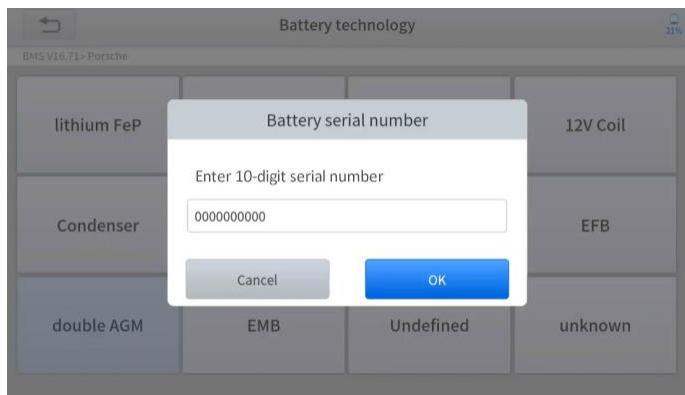

5.6 THROTTLE

Throttle Position Sensor (TPS) Match, this function enables you to make initial settings to throttle actuators and returns the “learned” values stored on ECU to the default state. Doing so can accurately control the actions of regulating throttle (or idle engine) to adjust the amount of air intake.

The operation guidelines of the Throttle function are shown as below:

1. Enter the **Throttle** menu and choose relevant models according to the vehicle being tested.
2. Enter the **Auto Recognition** menu and turn on the ignition switch.
3. Read carefully and complete the **requisites** listed before performing the throttle regeneration function. And press **OK** after completing the instructions shown.

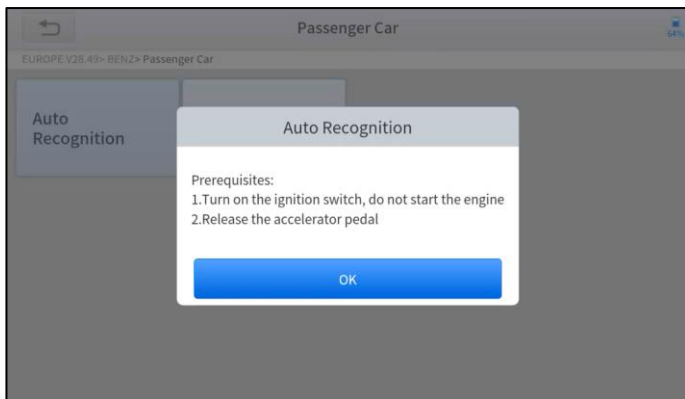

4. Wait until all the parameters are read and displayed.

Auto Recognition

EUROPE V28.49> BENZ> Passenger Car

Engine speed(rpm)	0	<= 10
Coolant temperature(deg C)	48.00	5.00-100.00
Intake air temperature(deg C)	12.00	<= 40
Accelerator pedal position(%)	0.39	<= 5
Throttle regulator	Already learned	Status

F1:Exit F2:Match the throttle limit position

F1 F2

5. Press the **F2** button and wait until a message of **'Match successfully'**

pops up.

5.7 INJECTOR CODING

This function can write the identification code of the fuel injector into the ECU so that the ECU can recognize and work normally. Write actual injector code or rewrite code in the ECU to the injector code of the corresponding cylinder for controlling accurately and correcting cylinder injection quantity.

After the ECU or injector is replaced, the injector code of each cylinder must be confirmed or re-coded so that the cylinder can better identify injectors to accurately control fuel injection.

① In general cases, there is no need to do the coding matching function after cleaning.

① The identification of the fuel injector includes its working accuracy value and type value. When replacing it, you need to find the corresponding model for replacement.

① At present, mainstream cars support injector coding functions.

The operation guidelines of the Injector Coding function are shown as below:

1. Enter the **Injector coding** menu and choose relevant chassis models according to the vehicle being tested.
2. Enter the **Fuel injection nozzle injection volume adjustment** menu.
3. Read the note displayed carefully and press **OK** after the reading.

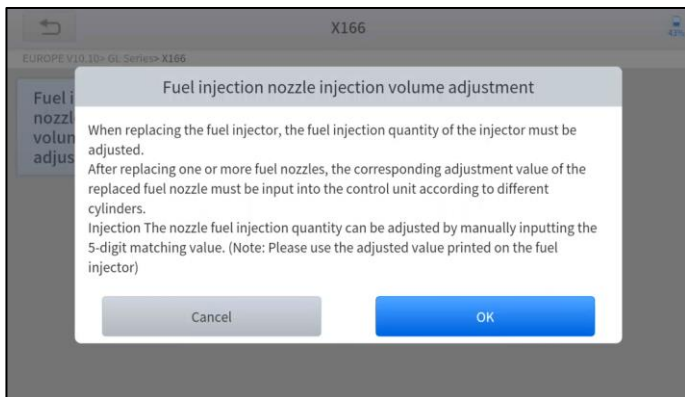

4. Read and confirm the value stored in the cylinders.

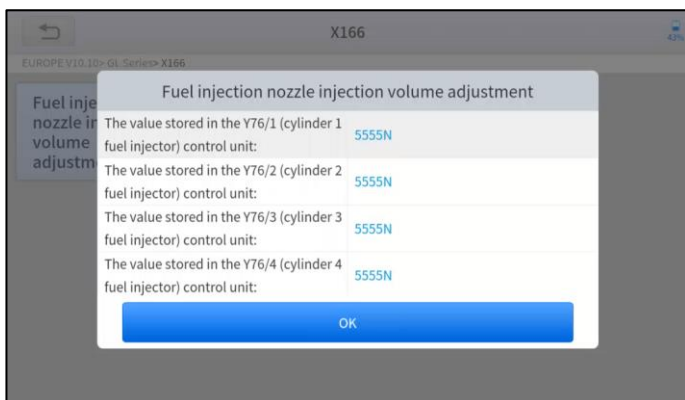

5. Enter the **Change the value of cylinder** menu of the replaced injector(s), enter the **new 5-digit value**, and then press **OK**.

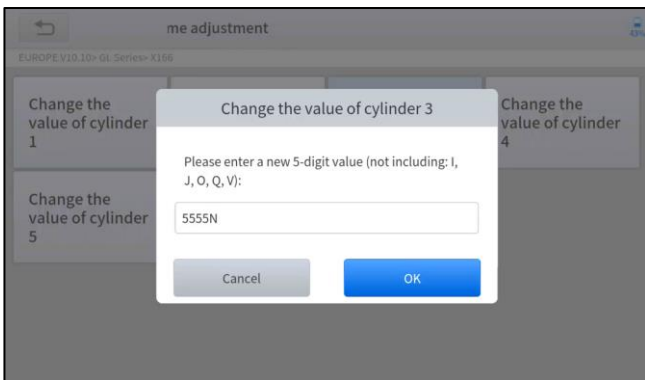

6. Wait until the message '**Write successfully**' pops up.
7. Turn off the ignition switch.
8. Wait until the message asked you to turn on the ignition switch.
9. Re-enter the **Fuel injection nozzle injection volume adjustment** menu to check whether the new value(s) are shown.

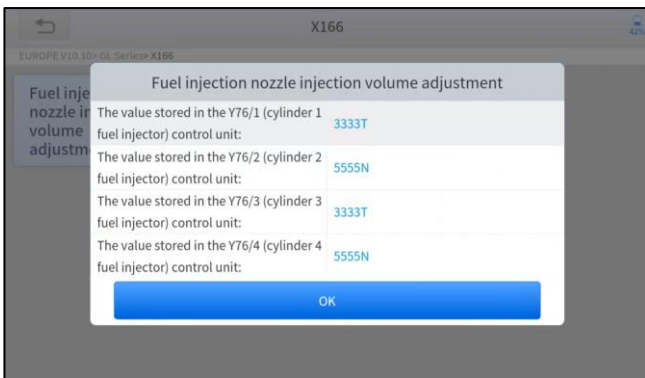

5.8 GEARBOX MATCH

After changing the gearbox or changing the gearbox ECU, you need to use the gearbox matching function to re-match the engine and the gearbox.

① Before resetting the gearbox, please check the gearbox control unit to ensure that there is no fault code. If there is a fault code, the gearbox memory function cannot be reset. Please road test after reset.

The operation guidelines of the Gearbox Matching function are shown as below:

1. Enter the **Gearbox matching** menu and choose relevant models according to the vehicle being tested.
2. Enter the **Reset adaptive value** menu.
3. Turn on the ignition without starting the engine.
4. Read the note and press **OK** to continue the Gearbox Matching function.

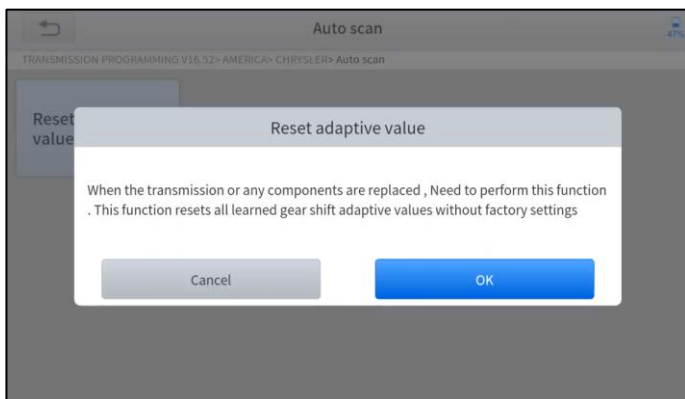

5. Wait until the message '**Successful operation**' pops up.

5.9 GEAR LEARNING

The crankshaft position sensor learns crankshaft tooth machining tolerance and saves to the tablet to more accurately diagnose engine misfires. If gear learning is not performed for a car equipped with a Delphi engine, the MIL turns on after the engine is started. The diagnostic device detects the DTC P1336 'Gear not learned'. In this case, you must use the diagnostic device to perform gear learning for the car. After gear learning is successful, the

MIL turns off. This function can complete the self-learning of the gearbox and improve the quality of shifting.

After the engine ECU, crankshaft position sensor, or crankshaft flywheel is replaced, or the DTC 'gear not learned' is present, gear learning must be performed.

The operation guidelines of the Gear learning function are shown as below:

1. Enter the **Gear learning** menu and choose relevant models according to the vehicle being tested.
2. Turn on the ignition switch to start the vehicle.
3. Enter the **Tooth Learning** menu.

Read carefully and complete the **requisites** listed before performing the gear learning function. And press **OK** after completing the instructions shown

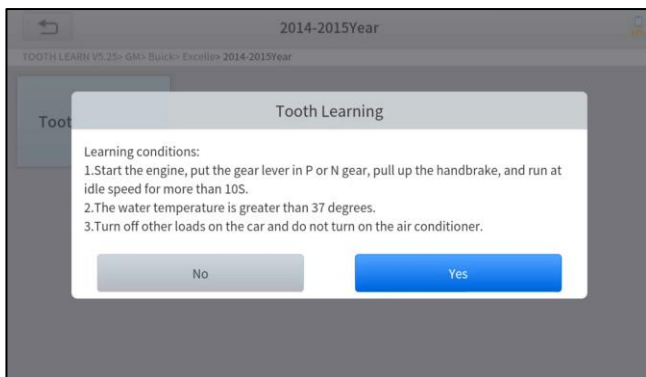

4. Read the instructions displayed and press **Yes** to start the learning process.

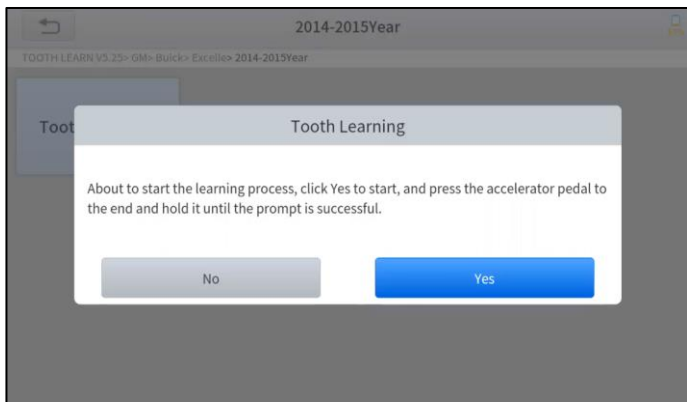

5. **Press the accelerator pedal** down and hold it until a message of 'The learning is successful, please release the accelerator pedal.' pops up.
6. Release the accelerator pedal and press **OK** to exit the gear learning function.

5.10 EEPROM ADAPTER

EEPROM chip stores the immobilizer data (like pincode) and odometer data, and sometimes you need to unsolder it to read & write the data inside the chip. For X100PAD PLUS you can use an EEPROM adapter to do that, and you can get access to its full function via this special function. In this function you can read the pincode, flash the data, write start, data recovery, mileage adjustment and so on.

7 SETTINGS

Click the Settings button to adjust the default settings and view information about the IK618 Smart Diagnostic System. There are seven options available in the system settings:

- **Language**
- **Units**

- **My Workshop Info**
- **VCI Info**
- **About**

LANGUAGE

The languages supported by this device are listed in **Settings**. In areas outside the English area, the default language is English and the local official language. Users can switch between English and local official languages on the device by themselves. If you need to switch other languages, please contact the dealer to unbind the current language configuration and rebind it to the language configuration you need to switch. After the configuration is successfully changed, you can switch the target language.

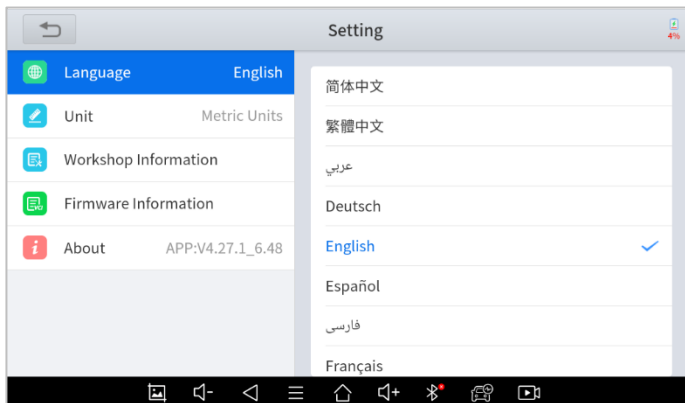

① This will only change the language of the APP. If you want to change the system language, please go to Android Settings.

■ How to change the language of your software?

- **Step1:** Contact your dealer and leave a message about the language you need and the S/N of your device, The technician will modify the language configuration for you in the background.
- **Step2: Settings->Language->Choose language**
- **Step3: OS Settings->Language & input->Choose Language**

- **Step4:** Back to **Updates** to pull all packages again

UNITS

You can switch the unit used by the system. IK618 Smart Diagnostic System provides you with **Metric**, **Imperial**, and **U.S. units**. You can directly click on the unit you need, after the switch is successful, a blue checkmark will be displayed behind the unit's name.

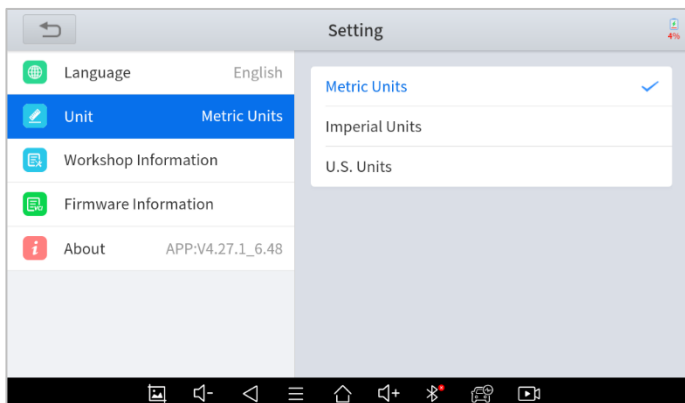

MY WORKSHOP INFO

Click on **My Workshop Information**, you can input your workshop information here. As shown in the figure below, you just need to fill in the valid information in the corresponding column and click "**SUBMIT**". And then it will show your workshop information in the report when you generate a diagnostic report, including your company name, address, website, telephone, and mailbox.

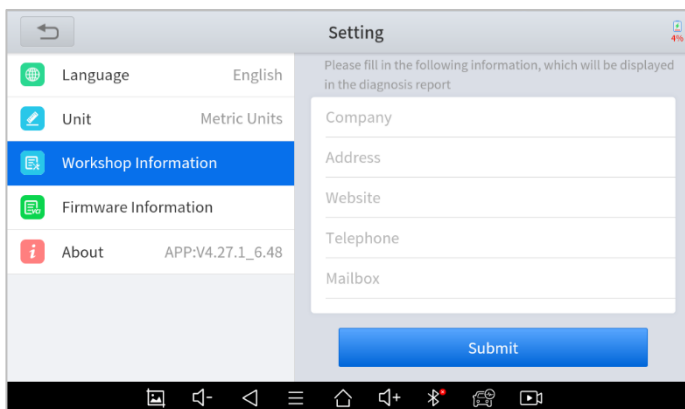

FIRMWARE INFORMATION

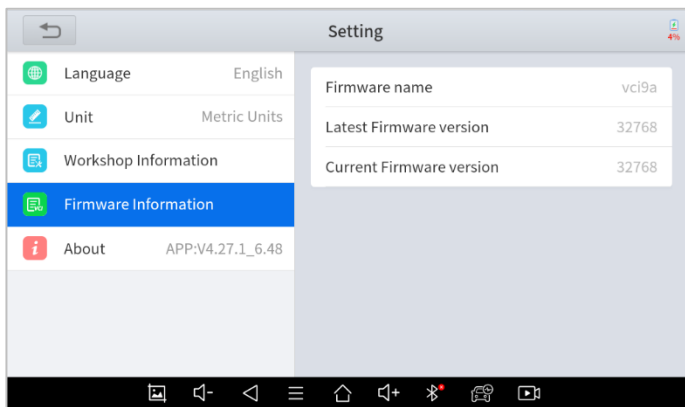

You can view the firmware information here, including the firmware name, the latest firmware version, the currently used firmware version, and the VCI firmware type.

① The Diagnostic tablet supports automatic firmware update, please make sure that the device is connected to the network when you enter the diagnostic software and the firmware will be automatically updated to the latest version.

ABOUT

Tap on **ABOUT**, you can check the serial number and APP version on here.

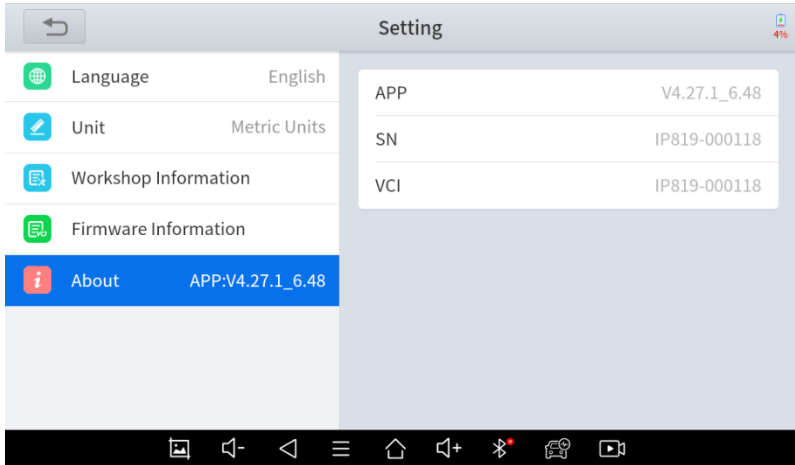

8 REPORT

Diagnostic Report is used for viewing and printing the saved files, such as Live Data, Trouble codes or pictures generated in the process of Diagnostic, users also can view a record of which cars have been previously tested. It includes 3 parts:

- **Report**
- **Replay**
- **File Management**

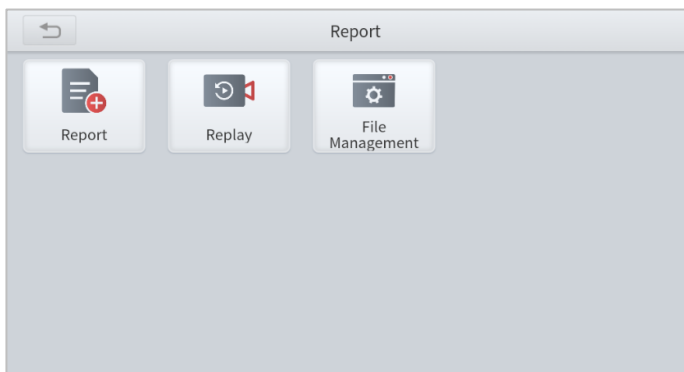

REPORT

This feature provides a history of diagnostic reports, where you can view and delete the vehicle's diagnostic reports according to your needs.

When you finish the diagnostics progress, and exit the software of car make, you will get a prompt of **report** regeneration.

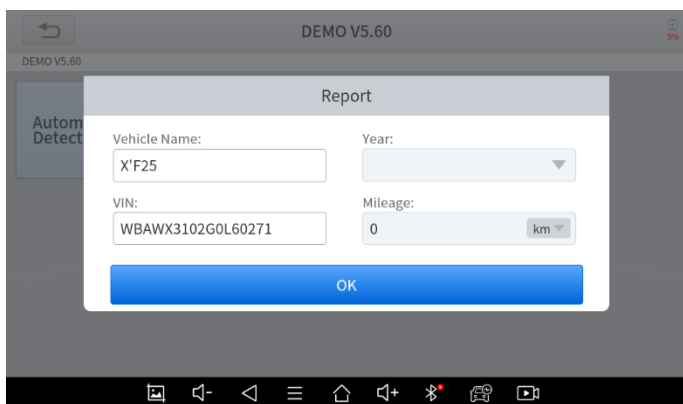

When you open the report, located in the header of the table is the studio information you filled in advance in the system setup, then the information of the vehicle, as shown as below:



① The vehicle information is allowed to edit by click the pen icon.

■ Print PDF Report

As you can see, you also could click " **Print PDF Report** " at the bottom right corner to output the pdf report. If you need to close the report, you could tap on the button " **Exit** ".

Please follow the below steps to print your report ▼

Step 1: Install an APP that can drive your target printer. Add the printer and input the IP address of the printer in the APP, or you can contact your dealer for help.

① IK618 Smart Diagnostic System doesn't provide the printer driver software, please install a third part App on the tablet if you need the print your Diagnostic report.

Step 2: Back to the Android main menu, go to Settings -> Printing-> Turn printer on.

Step 3: Report-> Choose report-> Print PDF Report-> Print

Step 4: Click the top-left corner of the screen and choose the printer you added before. Then click the button on the right to print.

REPLAY

This function allows you to replay the living data recorded during the Diagnostic process.

Before replaying the living data, please make sure you have recorded the live data during the Diagnostic

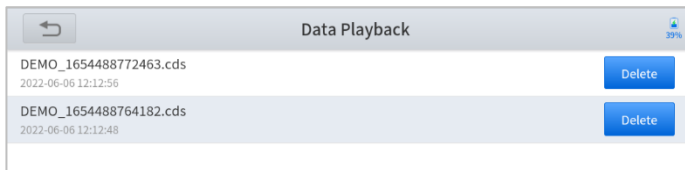

The screenshot shows the 'Data Playback' screen displaying a table of recorded data values. The table has four columns: NO., Name, Value, and Unit. The data is as follows:

NO.	Name	Value	Unit
1	Speed reading	0.00	km/h
2	Total distance (instrument cluster display) (conversion factor km/1.6 = mile)	40352	km
3	Revolution counter	840	1/min
4	Outside temperature sensor	50.00	deg C
5	Total distance (absolute value)	40356	km
6	Fuel level sensor, right	23.00	l

Below the table, there is a play/pause button and a navigation bar with various icons.

FILE MANAGER

This function allows you to check and delete files on the device. Please use this function under the guidance of professionals. We do not suggest to use this by yourself, as it may cause software missing or malfunctioning.

9 REMOTE ASSISTANCE

Tap on "**Remote**" to start the TeamViewer quick support program, which is a simple, fast, and secure remote-control screen. You can use this application to enable them to control your tablet on a PC through the TeamViewer software, thereby obtaining temporary remote support from XTOOL's technical support centre.

Computers and mobile devices running TeamViewer are identified by a globally unique ID. When the remote application is started for the first time, the ID will be automatically generated according to the hardware characteristics and will not be changed in the future. This TeamViewer ID can individually access all TeamViewer clients.

Before launching the remote desktop application, make sure that the tablet is connected to the Internet so that you can access the tablet to receive remote support from a third party. If you encounter problems and are not able to solve them, you could open this application and ask for remote assistance.

To obtain remote support from your partners or XTOOL After-service Center:

1. Turn on the power of the tablet.
2. Click **Remote** in the Diagnostic application. The TeamViewer screen is displayed, and the device ID will be generated.
3. Your partner must install the remote-control software on his/her computer by downloading the full version of the TeamViewer program (<http://www.teamviewer.com>) online, and then start the software on his/her computer at the same time, to provide support and remote control of the tablet.
4. Provide your ID to the partner or XTOOL technician, and then wait for him/her to send you a remote-control request.
5. A pop-up window will be displayed, asking you to confirm to allow the remote-control program to control your device.

6. Click Allow to accept, or click Reject to reject.

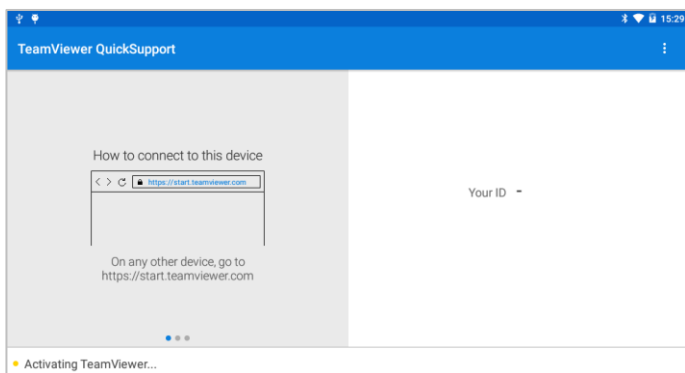

① Sometimes we cannot connect to your device because the Teamviewer on your device is too old and needs to be updated. To fix that, Open the web browser using the device, and it will guide you to XTOOL official website. Click “Support – Download Center”, find Teamviewer and click download. After you have downloaded the apk file, open it and install the latest app, and we will be ready to go.

10FAQ

Q1: FAILED TO GENERATE DIAGNOSTIC REPORT

1. Currently this could only be used when performing diagnostic functions, like read ECU information, read code and clear code, live data, freeze frame, which can trigger a diagnostic report. Other functions, such as immobilization and maintenance services will not be displayed in the report.
2. After entering the Diagnostic menu, you need to perform one specific function before the system can generate a Diagnostic report normally.
3. After the Diagnostic is completed, you need to step back to the previous menu step by step to generate the Diagnostic report successfully. If the APP is killed directly, the report cannot be triggered.
4. If the report still cannot be generated after troubleshooting according to the above prompts, please try to exit the APP, enter the system settings, and then choose to clear the APP cache.

Enter the path: Android System Setting>>Apps>>Diagnostic>>Clear Cache

Sample as follows:

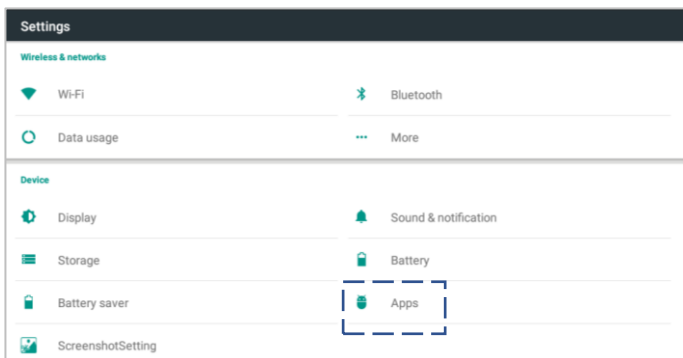

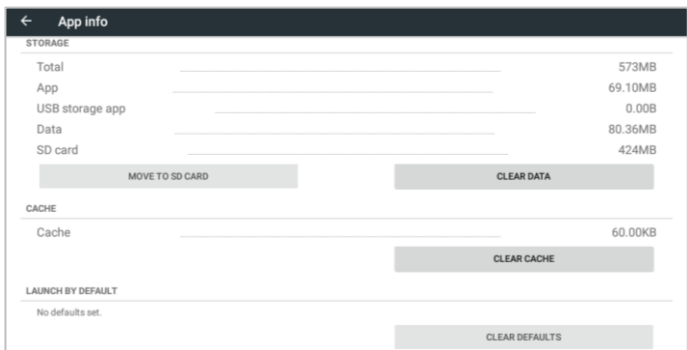
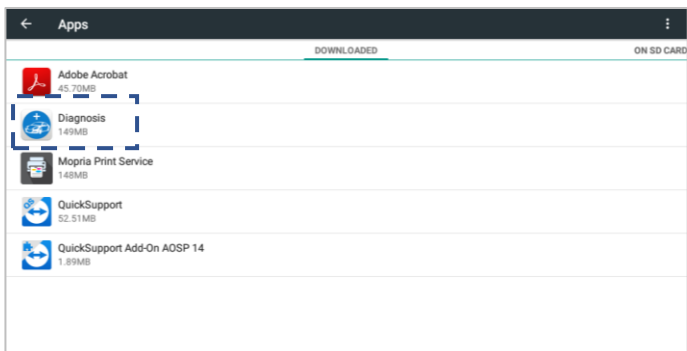

Q2: HOW TO PRINT DIAGNOSTIC REPORT

The XTOOL device is compatible with third-party print drivers. You can download the printer driver you need in the browser that comes with the tablet to install it, and then set your printer in the OS settings. After the setting is completed, you can print it in the **Report**.

Q3: FAILED TO EXTRACT FILES

Since the XTOOL tablet is equipped with an Android system, you have to confirm the system type of receiver.

For Android: supports transferring files via Bluetooth, USB cable, etc.;

For IOS: only supports transferring files through a wired connection (Bluetooth connection is not available).

Q4: MAILBOX SUPPORTED

The Diagnostic tablet supports various mailboxes, including Hotmail, outlook, yahoo and Gmail, etc. When you set up the email, please make sure that the email client configuration address you entered is correct.

Q5: HOW TO MAKE AN APPOINTMENT FOR REMOTE SUPPORT

Please contact your dealer, or send an email to our technical support center. (Email address: supporting@xtooltech.com) And our technical support team will confirm the time of remote support with you.

Q6: HOW TO GENERATE AND UPLOAD DIAGNOSTIC LOG FILES

The IK618 tablet will automatically generate and store the diagnostic logs. When the device is connected to the Internet, it will automatically upload all the stored diagnostic logs to the backend system.

Q7: HOW TO SWITCH LANGUAGE

1. Contact your dealer and leave a message about the language you need and the S/N of your device, The technician will modify the language configuration for you in the backend system.
2. **Settings->Language->Choose language**
3. Back to **Updates** to update all the software again

Q8: SHOWING “COMMUNICATION FAILED”

1. Contact your dealer to confirm whether the vehicle model is supported by the scan tool you owned.
2. Check whether the vehicle is properly connected (e.g. whether the ignition is ON, and the Diagnostic of some vehicle need to turn on the engine), If your tablet is equipped with a VCI box, please check the status of VCI box indicator.
3. Confirm whether you have entered the correct Diagnostic menu.
4. Confirm whether the **AUTO-SCAN** function can assist you to enter the correct Diagnostic menu, or whether **OBDII** function work.
5. Check whether the software is the latest version, if not, please update to the latest version first.

Q9: FAILED TO ACTIVATE OR REGISTER

- For ‘Activation Failed’

Generally caused by network instability, please switch to a more stable network and try to activate again.

- For ‘Registration Failed’

Generally, it is caused by the connection timeout or the sending timeout, please check whether you have blocked the outgoing network traffic to non-US regions like China. We recommend that you unblock and try to register again.

Q10: FAILED TO TURN ON WHEN CHARGING

In the charging state, you need to first press the power button to light up the screen(showing the charging status). Then press and hold the power button for 4-5 seconds until the boot animation is shown on screen.

Q11: FAILED TO OPEN THE DIAGNOSTIC APP

The tablet has to connect to the network every 30 days, otherwise, the Diagnostic app will be locked and disabled until the device is connected to the network.

Q12: HOW TO FACTORY RESET THE DEVICE

Please go to Android settings – Backup & reset – Factory reset. Before you reset, make sure you are still in subscription. This will delete all the software and you cannot download any software if you are out of subscription.

Q13: SHOWING “LICENSE EXCEPTION”

If this only happened on some of the software, click the software and hold it until it shows a box and delete button above. Choose the software and delete it, then go to updates and re-install this software and see if it works.

If this happened on all the software, try delete all the diagnostic files this device. And if it still doesn't work, please contact Xtool aftersales services.

Q14: SHOWING “FAILED” WHEN GOING INTO MENUS

Try delete and re-install the software.

Q15: HOW TO FREE THE STORAGE SPACE

There are multiple ways to clear your storage space:

1. (Recommended) Delete some of the software you don't need. See 2) to check how to delete software.
2. (Recommended) Go to Report – File Manager – Storage of diagnosis details, click edit button on the top-right corner of the screen, select Download folder and delete it. After that, please download the software packs one by one.

3. Factory reset the device, and tick “Erase SD card” before you start. Before you do that, make sure you are in subscription and can download the software updates.

Also, if you meet these issues frequently, you can avoid them by regularly delete some of the software that are not commonly used, or delete download folder regularly and do not download too many of them.

Q16: SOME OF THE SOFTWARE ARE MISSING

Please make sure you are using the language that supported in your area (see Q7), and your subscription is still not expired. If you have checked, please go to updates and check if you have downloaded the software.

11 COMPLIANCE INFORMATION

FCC COMPLIANCE

FCC ID: 2AW3IP710

This device complies with Part 15 of the FCC Rules. Operation is subject to the following two conditions:

- 1) This device may not cause harmful interference ;
- 2) This device must accept any interference received, including interference that may cause undesired operation.

Warning

Changes or modifications not expressly approved by the party responsible for compliance could void the user’s authority to operate the equipment.

Note

This equipment has been tested and found to comply with the limits for a Class B digital device, pursuant to Part 15 of the FCC Rules. These limits are designed to provide reasonable protection against harmful interference in a residential installation.

This equipment generates uses and can radiate radio frequency energy and, if not installed and used by the instructions, may cause harmful interference to radio communications. However, there is no guarantee that interference will not occur in a particular installation. If this equipment does cause harmful interference to radio or television reception, which can be determined by turning the equipment off and on, the user is encouraged to try to correct the interference by one or more of the following measures:

- Reorient or relocate the receiving antenna.
- Increase the separation between the equipment and receiver.
- Connect the equipment into an outlet on a circuit different from that to which the receiver is connected.
- Consult the dealer or an experienced radio/TV technician for help.

Specific Absorption Rate (SAR) information

This device meets the government's requirements for exposure to radio waves. The guidelines are based on standards that were developed by independent scientific organizations through periodic and thorough evaluations of scientific studies. The standards include a substantial safety margin designed to assure the safety of all persons regardless of age or health. FCC RF Exposure Information and Statement the SAR limit of the USA (FCC) is 1.6 W/kg averaged over one gram of tissue. Device types: This device has also been tested against this SAR limit. This device was tested for typical body-worn operations with the back of the tablet kept 0mm from the body. To maintain compliance with FCC RF exposure requirements, use accessories that maintain an 0mm separation distance between the user's body and the back of the tablet. The use of belt clips, holsters, and similar accessories should not contain metallic components in their assembly. The use of accessories that do not satisfy these requirements may not comply with FCC RF exposure requirements and should be avoided.

CE

Declaration of conformity

Herby, Shenzhen Xtooltech Intelligent Co., Ltd declares that this Car Diagnostics Tablet, P710 complies with the essential requirements and other relevant provisions of Directive 2014/53/EU. By Article 10(2) and Article 10(10), this product is allowed to be used in all EU member states.

UKCA

Herby, Shenzhen Xtooltech Intelligent Co., Ltd declares that this Car Diagnostics Tablet P710 satisfies all the technical regulations applicable to the product within the scope of UK Radio Equipment Regulations (SI 2017/ 1206); UK Electrical Equipment (Safety) Regulations (SI 2016/ 1101); and UK Electromagnetic Compatibility Regulations (SI 2016/ 1091) and declare that the same application has not been lodged with any other UK Approved Body.

SHENZHEN XTOOLTECH INTELLIGENT CO., LTD

COMPANY ADDRESS: 17&18/F, BUILDING A2, CREATIVITY CITY, LIUXIAN AVENUE, NANSHAN DISTRICT, SHENZHEN, CHINA

FACTORY ADDRESS: 2/F, BUILDING 12, TANGTOU THIRD INDUSTRIAL ZONE, SHIYAN STREET, BAOAN DISTRICT, SHENZHEN, CHINA

SERVICE-HOTLINE: 0086-755-21670995/86267858

EMAIL: MARKETING@XTOOLTECH.COM

FAX: 0755-83461644

WEBSITE: WWW.XTOOLTECH.COM