

Table of contents

1、 Safety precautions and warnings

1-1 Power supply precautions	03
1-2 Installation precautions	03
1-3 User precautions	03
1-4 Other precautions	03

2、 General information

2-1 Machine description	04
2-2 Machine characteristics	04

3、 Product packaging checklis

4、 Overview

4-1 Structure diagram	09
4-2 Specification	10
4-3 Software overview	11
4-3-1 Introduction	11
4-3-2 Smart phone operation system	11
4-3-3 Software update	11

5、 Installation instruction

5-1 Cutter and probe installation	12
5-2 Cutter and probe uninstallation	13
5-3 Clamp installation	14
5-4 Standard clamp guide	15
5-5 clamp range	16

6、 Operation instructions on APP

6-1 Height level adjustment	17
6-2 Standard clamp calibration	18
6-3 Cutting calibration	19
6-4 How to use cut by bitting	20
6-5 How to use all key lost	22
6-6 How to use find bitting	23

7、 How to use universal key duplicate

8、 How to use generate key type

9、 How to use customize key type

10、 How to use customize key data	30
11、 Decoder tool	
11-1 How to use decoder tool	33
11-2 How to find bitting via decoder tool	34
12、 Update	
12-1 APP update	35
12-2 Update key database	35
12-3 Firmware update	36
12-4 Update image	36
12-5 Update operation view	37
12-6 Update log	37
13、 Maintenance	38
14、 Warranty	38

1、 Safety precautions and warnings

To avoid injuries to operators, please read this product user manual carefully Before you start and follow the safety notes listed below

1-1 Power supply precautions

- Do not use damaged wires or loose socket
- Do not plug more devices at the same socket
- Do not pull wire or touch the metal part of power supply
- Unplug the machine when it is not in use for a long time
- If any problem happens, please contact technique support

1-2 Installation precautions

- Do not place the machine in a place that is damp, greasy and dusty
- Do not put things like candle or cigarette end on the machine
- Always use the machine under safe environment
- Put the machine on the stable platform

1-3 User precautions

- Do not have clothes, hair, hands and other tools close to the machine when it is working
- Do not put things like tool or container on the machine

1-4 Other precautions

- Do not disassemble the machine if you don' t get permission from factory technique support.
- Keep the children away from the machine when it is working

2、 General information

2-1 Machine description





Dear customer, thank you for using 2M2 tank automatic key cutting machine, it is a portable and light weight, especially designed for locksmiths in the world to work outdoor. To avoid injuries and damages to the machine, please use the machine correctly according to product user manual. Please read the manual carefully before you start to use the machine.





2-2 Machine characteristics



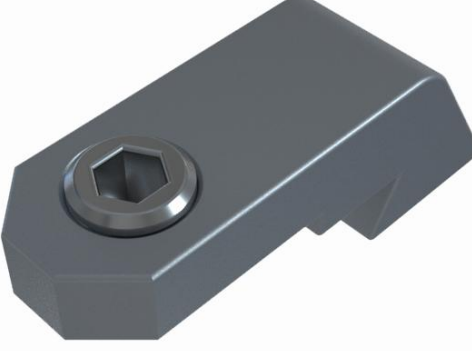
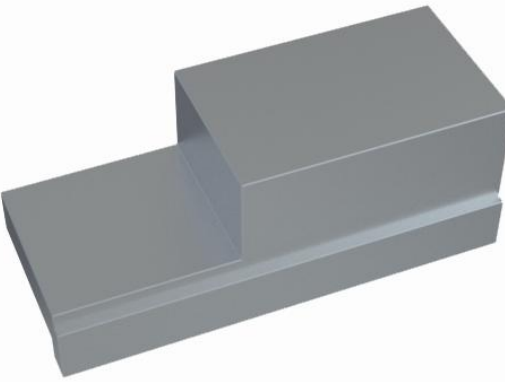

- Smart control and operation on APP and build-in database
- Portability and build-in Lithium battery with a long battery life (optional)
- Equipped with B clamp (standard clamp), F021 clamp (optional)
- Cutter and probe work in parallel
- Aluminum structure
- Imported ball screw with high precision
- Cross rail with high rigidity
- Supporting online update
- Operating in multiple languages

3、 Product packaging checklist

Name	Sample picture	Qauntity	Description
Machine		1	Key cutting machine
Adapter		1	Power supply
1.5m Power cord of Mainland China (optional)		1	Power Cord
1.5m Power cord of UK standard (optional)		1	Power Cord
1.5m Power cord of US standard (optional)		1	Power Cord
两插美规线 (选配)		1	Power Cord

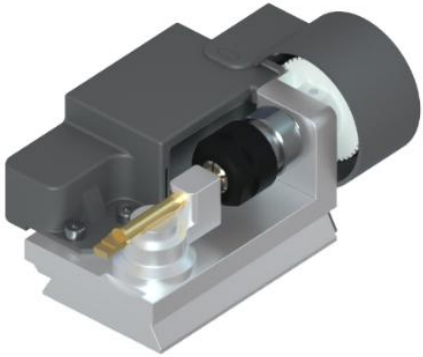
1.5m Power cord of EU standard (optional)		1	Power Cord
Power cord of Italy standard (optional)		1	Power Cord
Switzerland Standard (optional)		1	Power Cord
Battery		1	Key cutting machine Battery
Brush		1	Cleaning tool
2.0 cutter		1	2.0*7*D4-L35 cutter
1.5 cutter		1	1.5*5*D4-L35 cutter
1.0 probe		1	1.0*7*D6-L35 probe
Standard clamp B		1	For single sided keys, double sided keys, internal track keys, external track keys, SX9, household Key.

		1	Clamp B D area
Standard clamp B		1	Clamp B area
		1	Clamp B-stopper (key position)
8.0 hexagon bar wrench		1	Clamp installation tool
2.0 hexagon bar wrench		1	Installation key tool
4.0 hexagon bar wrench		1	Single sided key Installation
2.5 hexagon bar wrench		1	cutter/probe installation tool

<p>F clamp (optional)</p>		<p>1</p>	<p>F021/TBE1 key clamp</p>
<p>Blue spanner for clamp F</p>		<p>1</p>	<p>For cap of clamp F</p>
<p>Red spanner for clamp F</p>		<p>1</p>	<p>For main axis of clamp F</p>
<p>Warranty</p>			<p>Machine Warranty</p>

4、 Overview

4-1 Structure



4-2 Specification

Input voltage	100-250V AC
Input frequency	50-60Hz
Power	190W
Power parameter	24V DC/8A
Battery capacity	65Wh
Principal axis rotation speed	10500rpm
Working temperature	-20°C-50°C
Humidity	10-90%
Gross weight	10KG
Net weight	17KG
Machine size	25.1cm*28.5cm*34.8cm
Package size	49.3cm*43.1cm*49.4cm

4-3 Software overview

4-3-1 Introduction

- Supporting self-calibration
- Supporting key duplication and cutting for vehicle/motorcycle/household keys
- Supporting universal key decode for multiple key types
- Operation on APP through Bluetooth
- Build-in key database

4-3-2 Smart phone operation system

- Android: Android 4.0 and above version
- IOS: IOS 8.0 and above version

4-3-3 Software update

- Online update on APP
- Update via upgrade suite

5、 Installation instruction

5-1 Cutter and probe installation

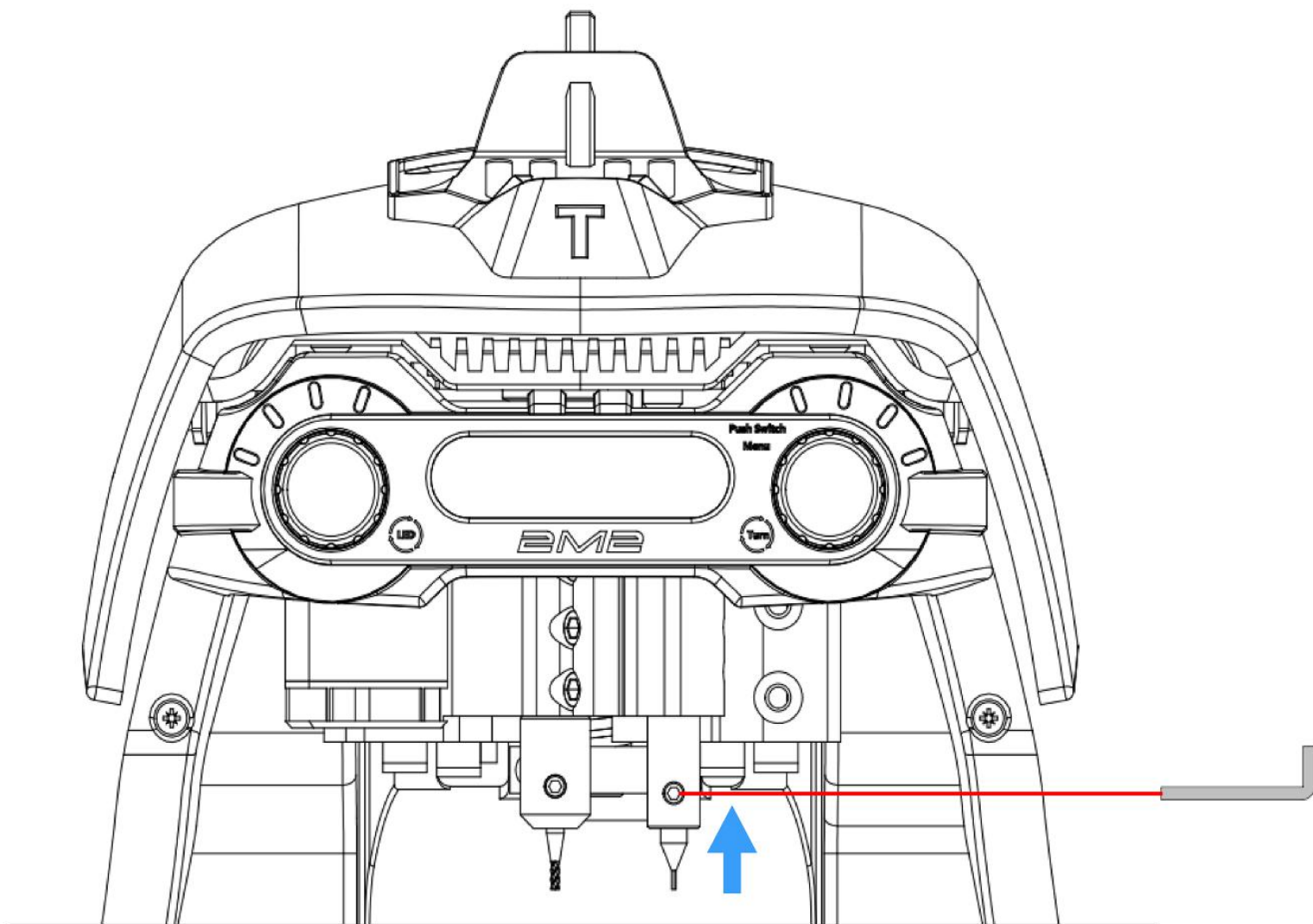

Installation steps:

Insert cutter and probe onto the top depend on the arrow, and then use 2.5mm hexagon bar wrench to lock the screw.

Notes: when pushing both cutter and probe onto the top, probe Height is higher than cutter height.

5-2 Cutter and probe unistallation

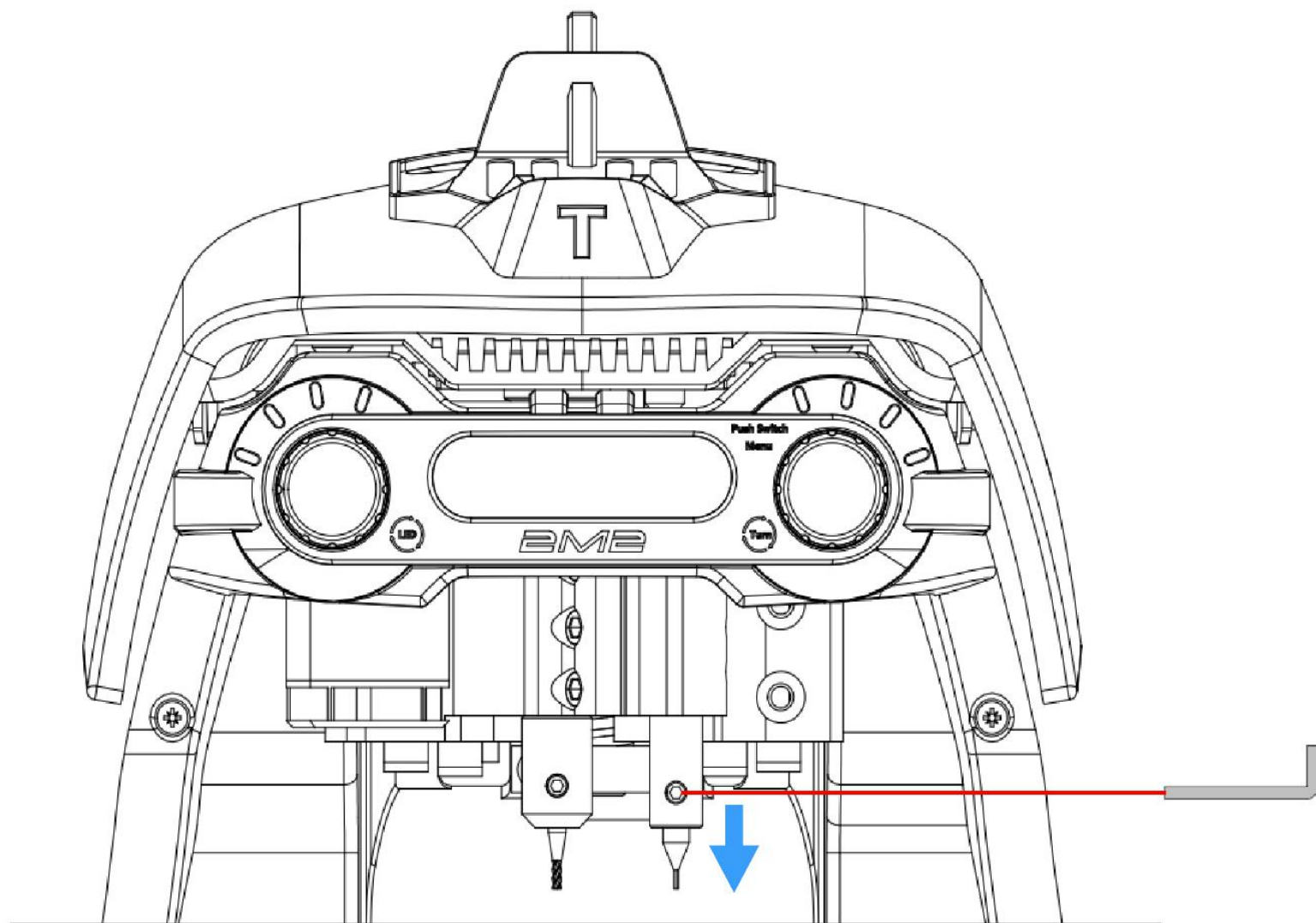

Unistallation steps:

Use 2.5mm hexagon bar wrench to unscrew the locks for cutter and probe until they are loosened off.

5-3 Clamp installation

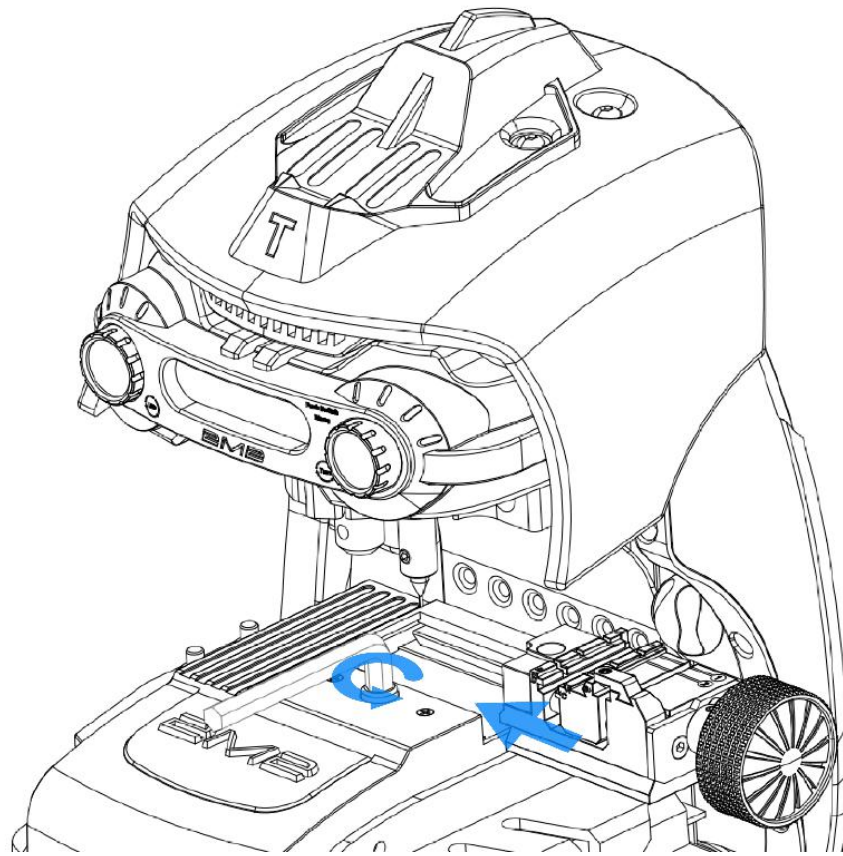

Picture 1

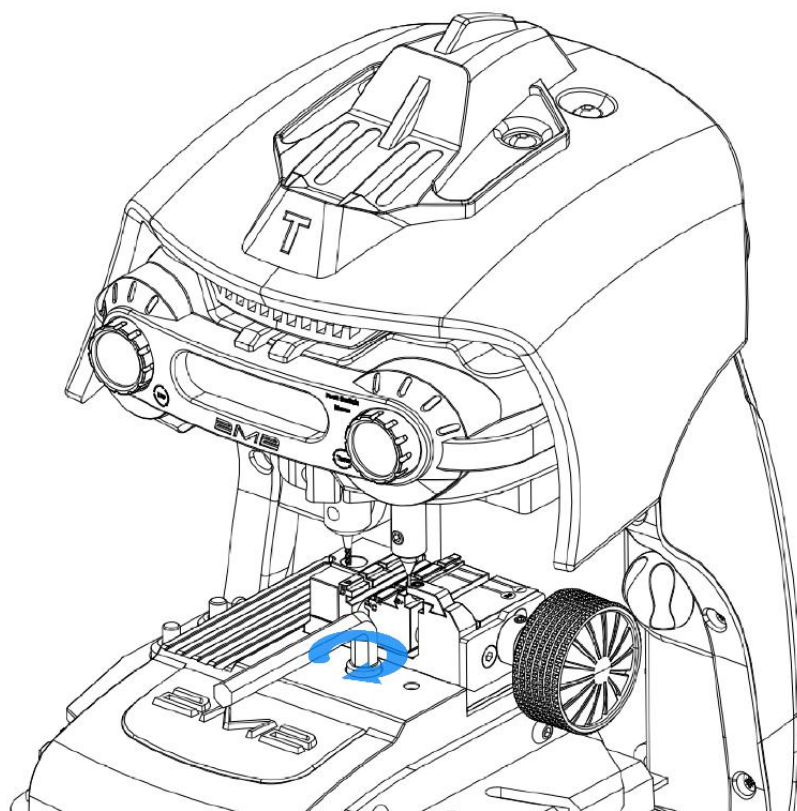

Picture 2

Installation steps:

Unscrew the lock for the clamp, insert the clamp along the rail depend on the arrow (picture 1). and then use 8mm hexagon bar wrench to screw the lock (picture 2).

5-4 Pictures of clamp

B Clamp

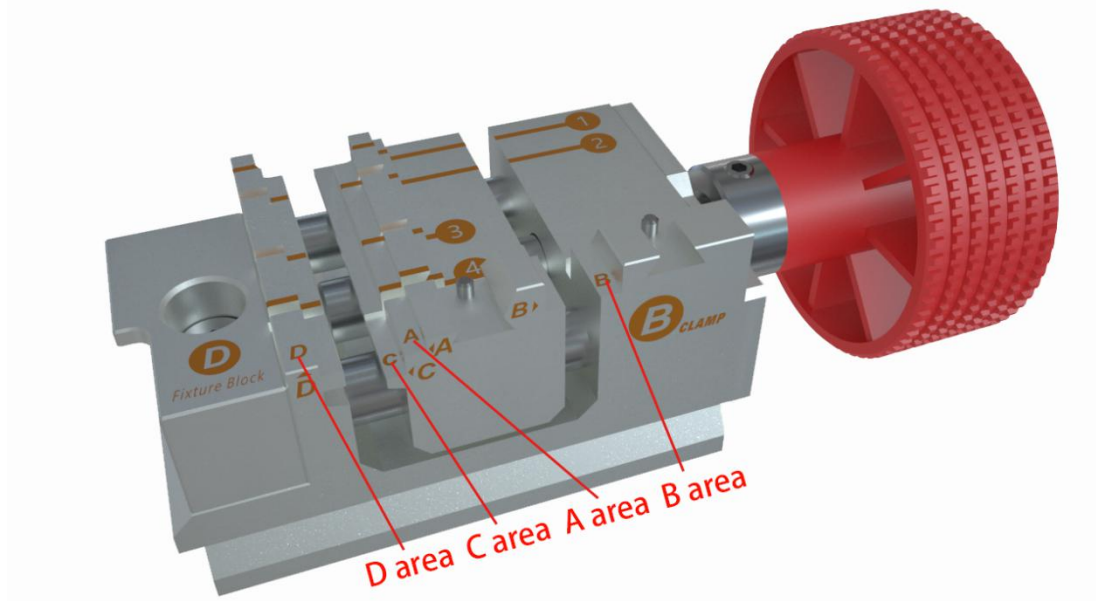

Supporting types

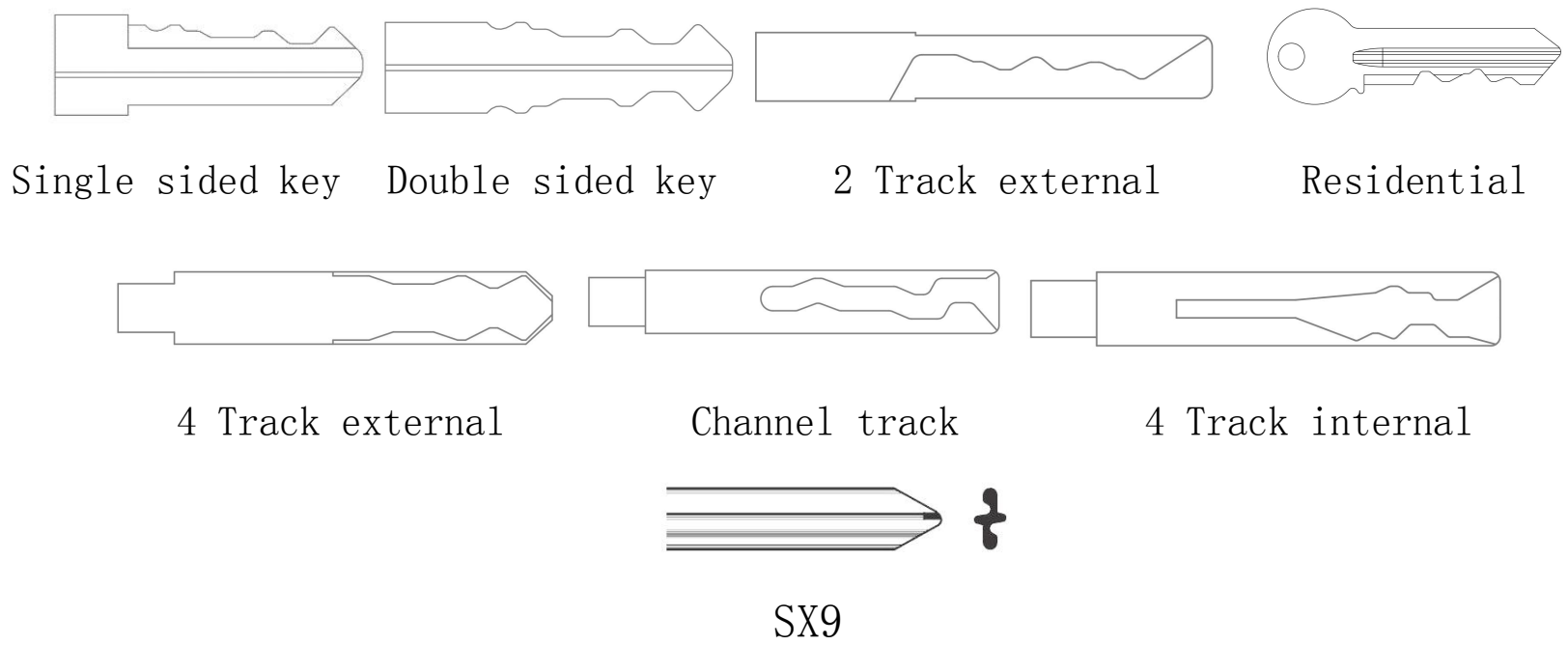

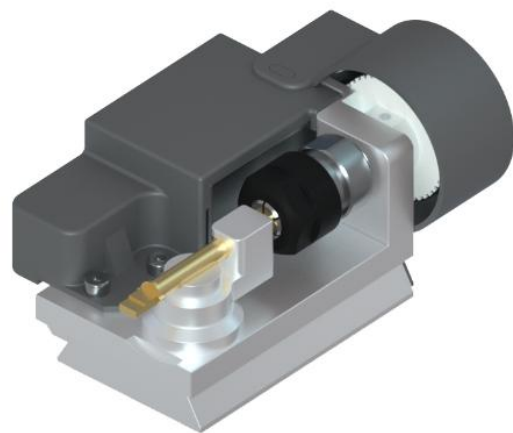

F Clamp (F021/TBE1)

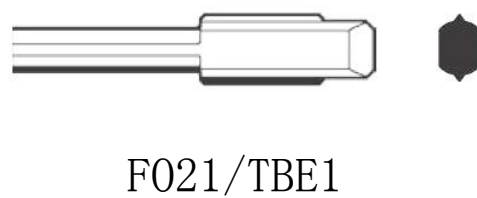

Supporting types

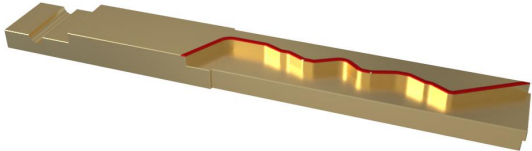
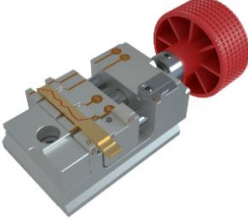
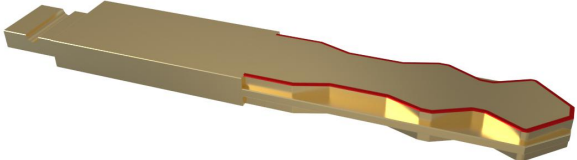
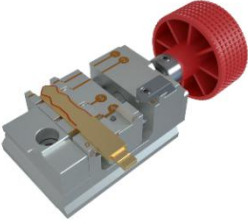
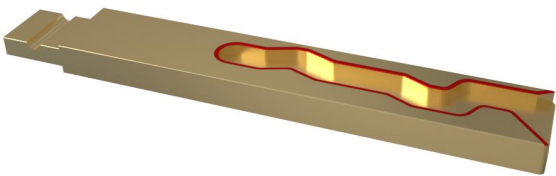
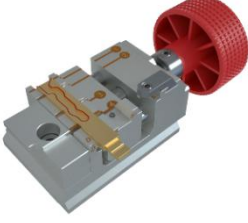
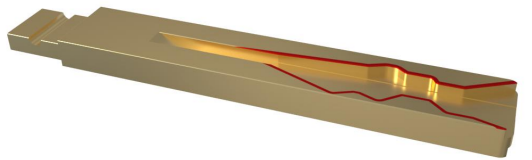
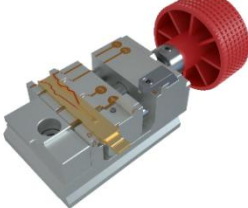
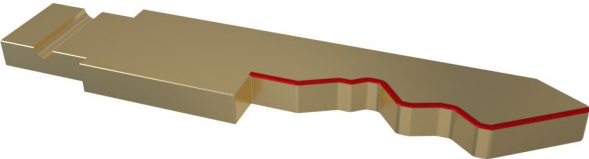
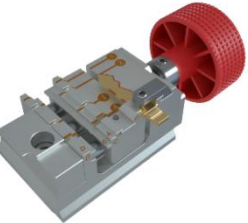
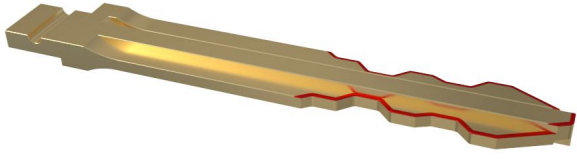
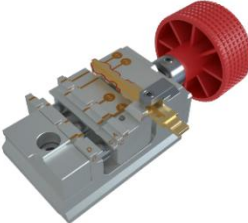
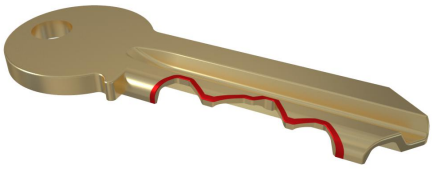
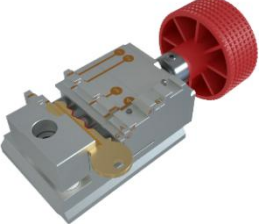
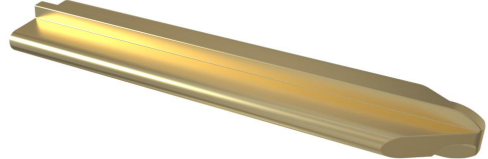
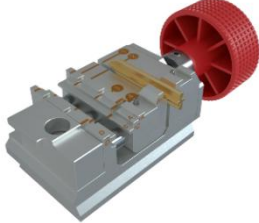
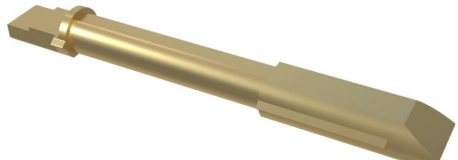

5-5 Standard clamp B range

Key types	Cutting side pictures	Clamp cutting sides	Description
2 track external			Clamp B A area
4 Track external			Clamp B A area
Channel track			Clamp B A area
4 Track internal			Clamp B A area
Single sided key			Clamp B B area
Double sided key			Clamp B B area
Residential key			Clamp B D area
SX9			Clamp B B area
F021/TBE1			Clamp F

6、 Operation instructions on APP

6-1 Height level adjustment

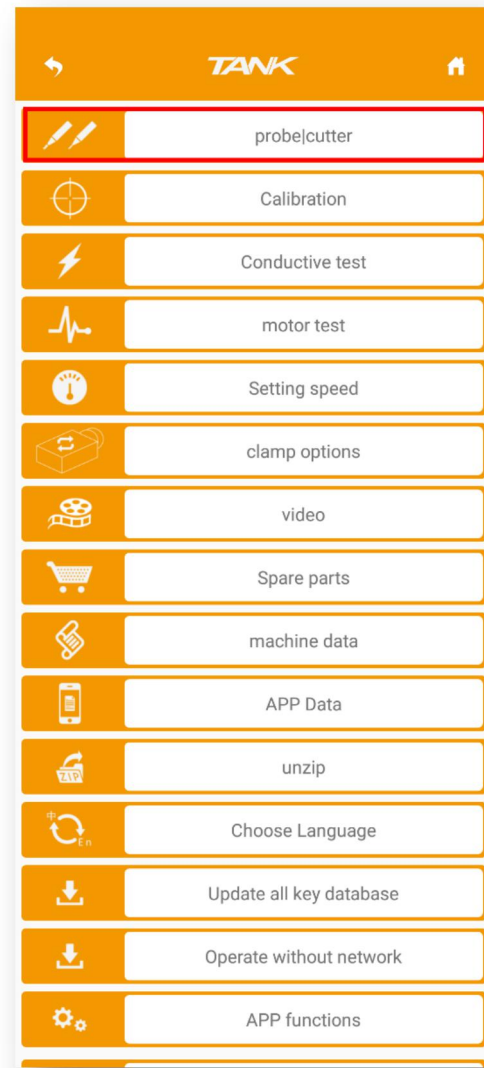
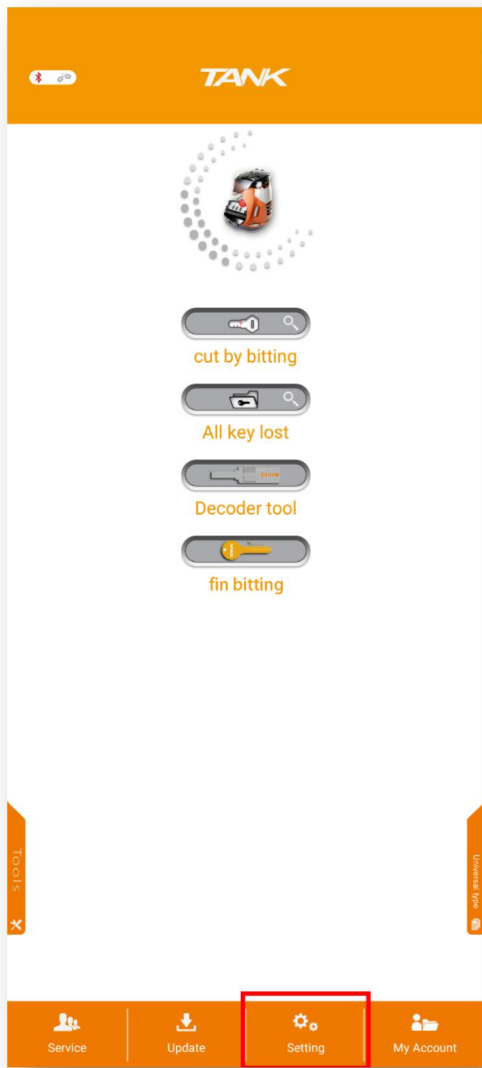

Enter 2M2 TANK main interface and click on “settings”

Click on “probe and cutter”

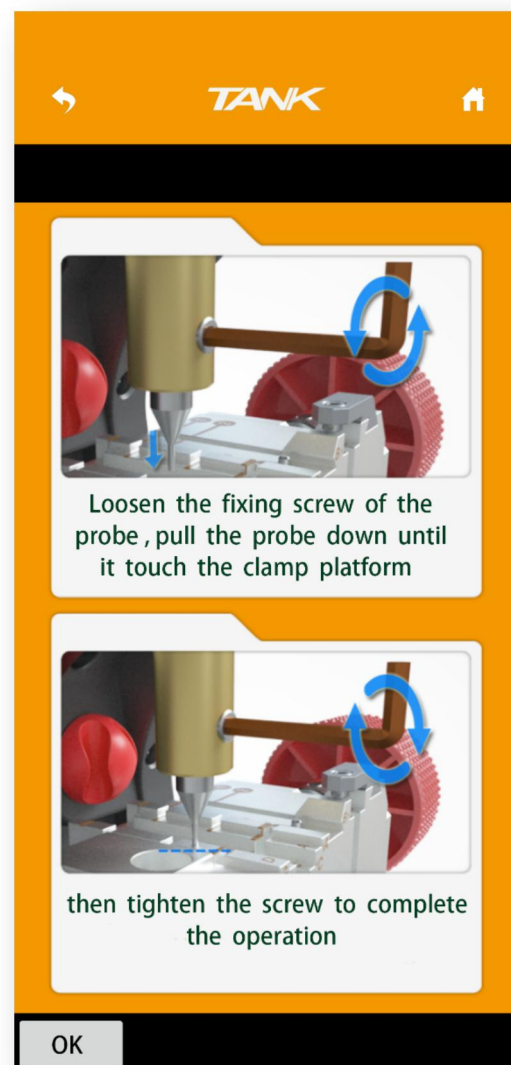
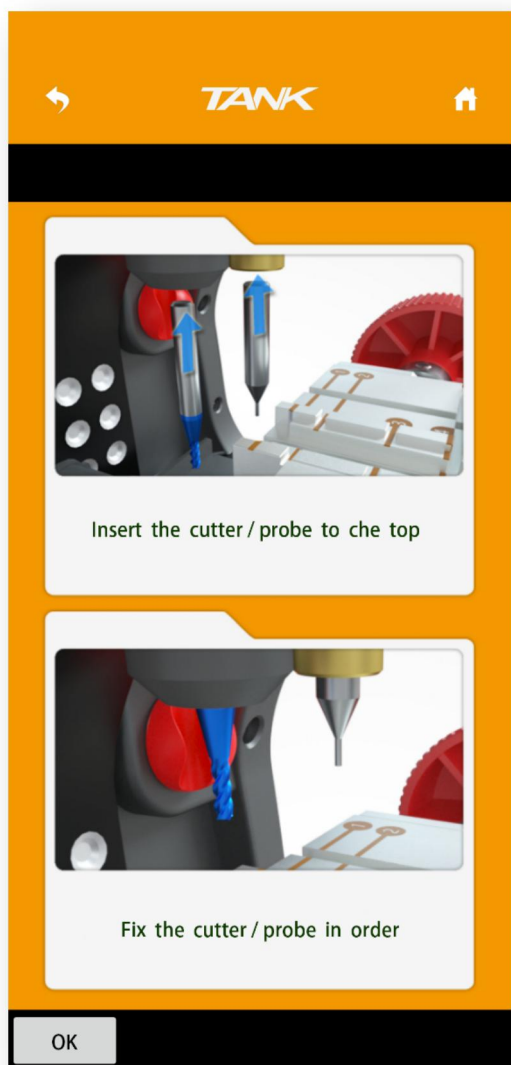

Installation and then click “OK”

Loosen off the screw until it touches the clamp

6-2 Standard clamp calibration

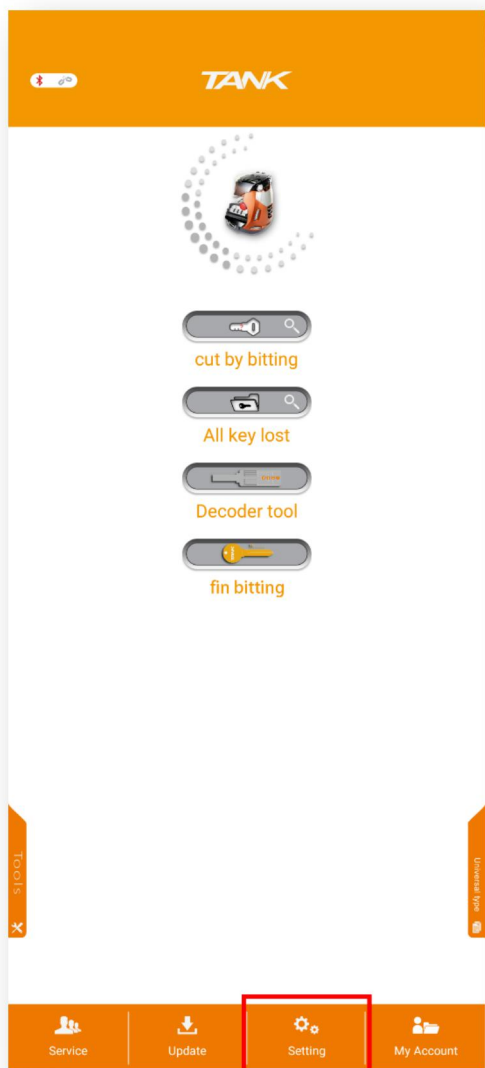

Enter 2M2 TANK interface, click “settings”

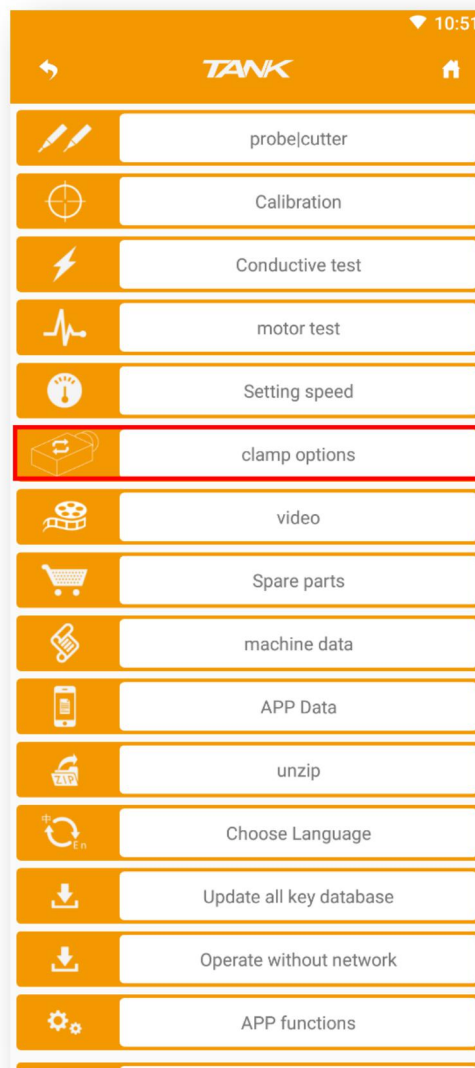

Click “clamp options”

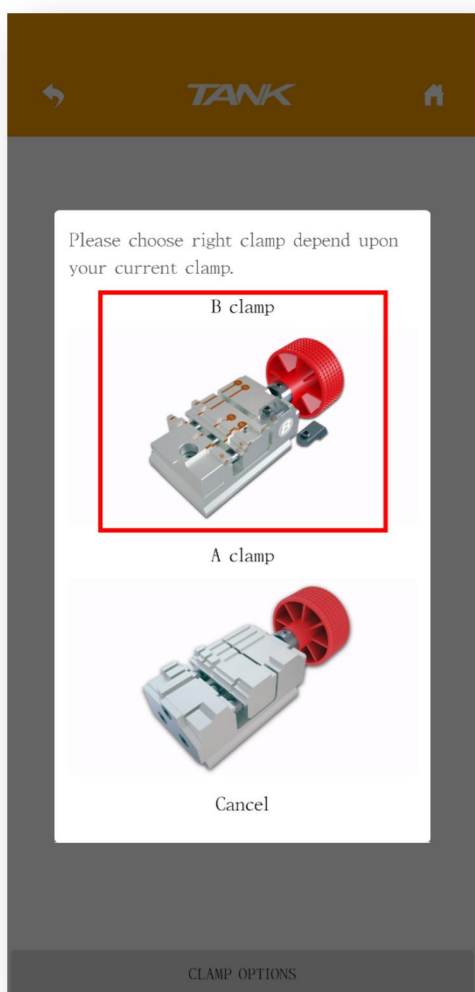

Select clamp depend on your current clamp”

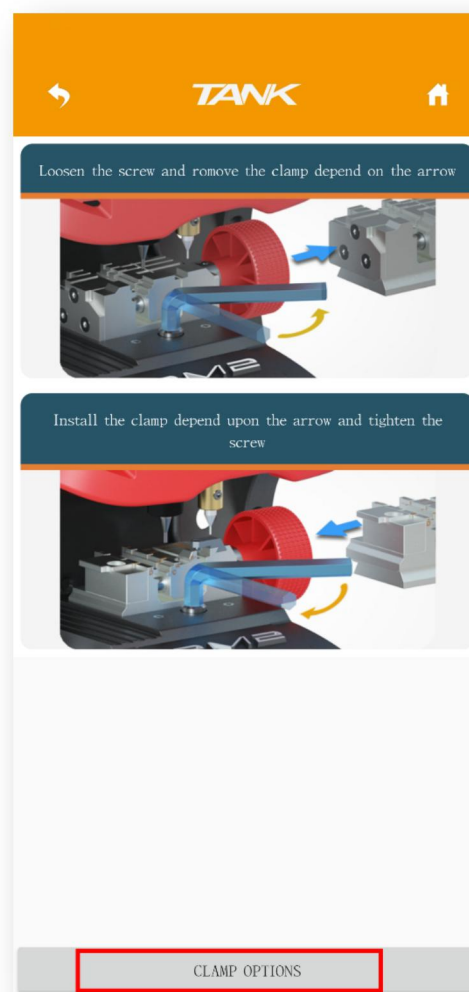

Remove the clamp from the picture instruction
(notes:If clamp B is ready, directly click “calibration”)

6-3 Calibration

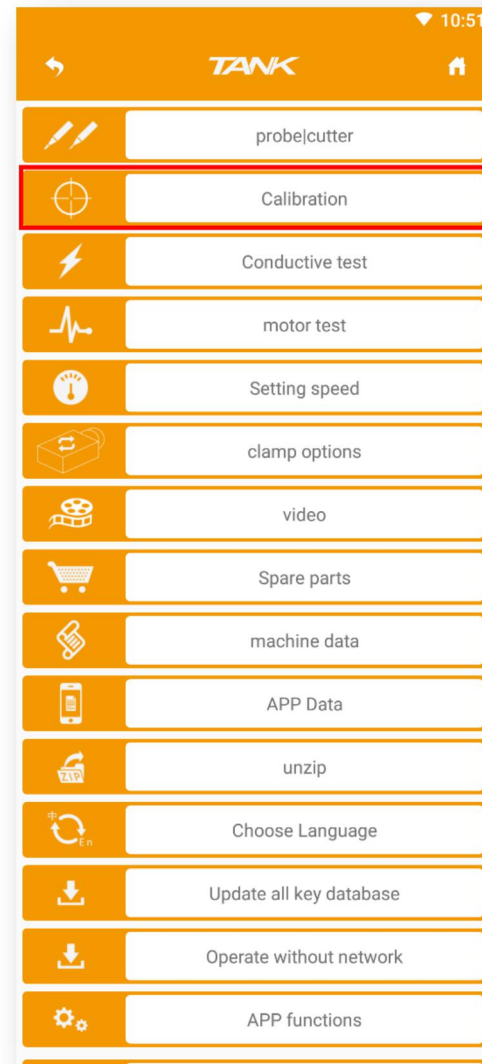
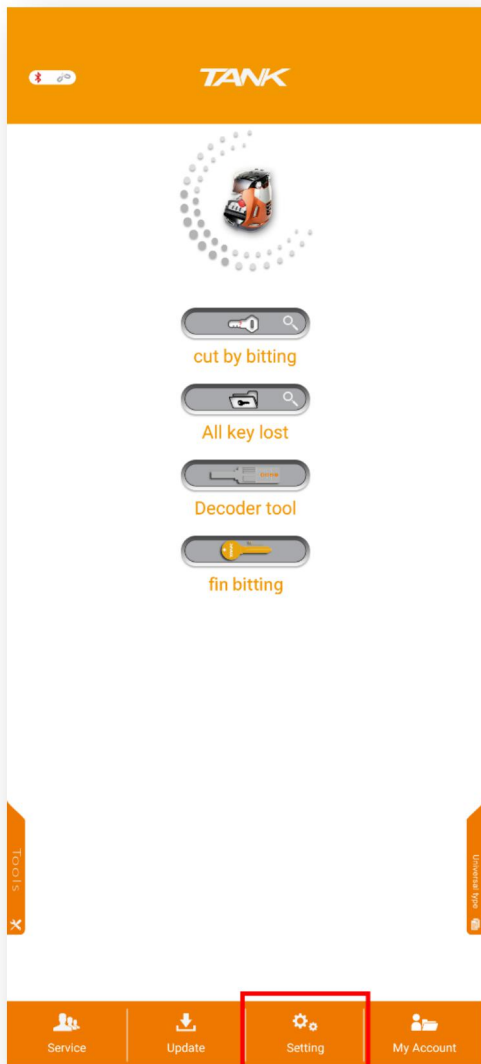

Enter “2M2 Tank ” interface, and then click on “settings”

click on “calibration”

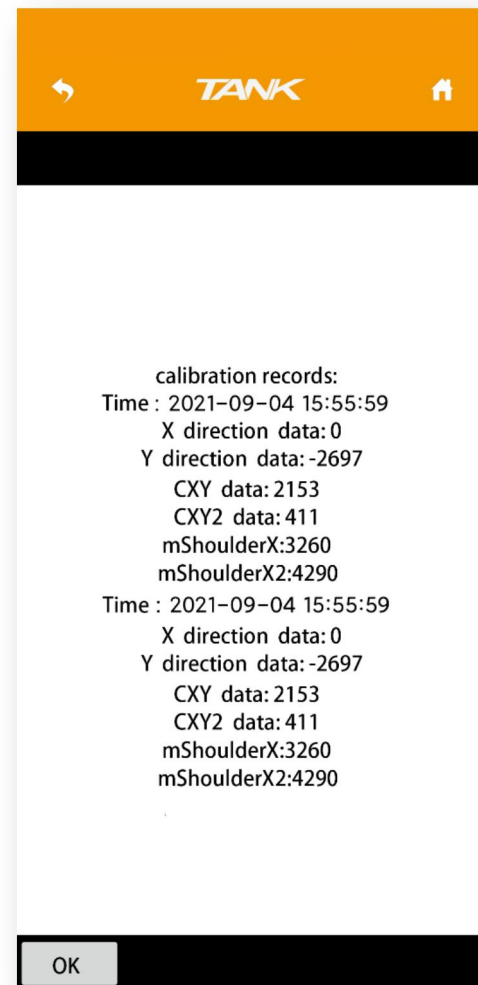
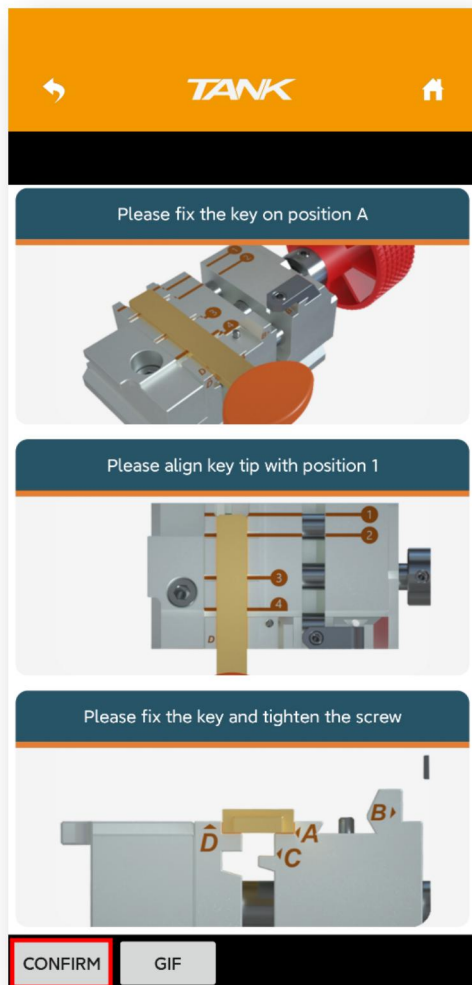

Install HON66 key blank,
Click “OK”

Clean the particles and click “OK”

If it's ready, click “OK”

6-4 How to use cut by bitting

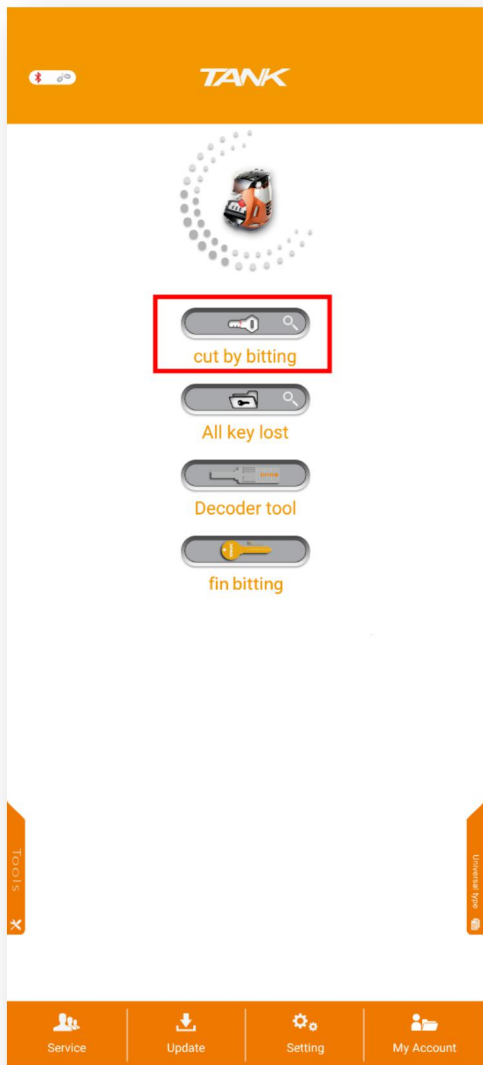

Click “cut by bitting”

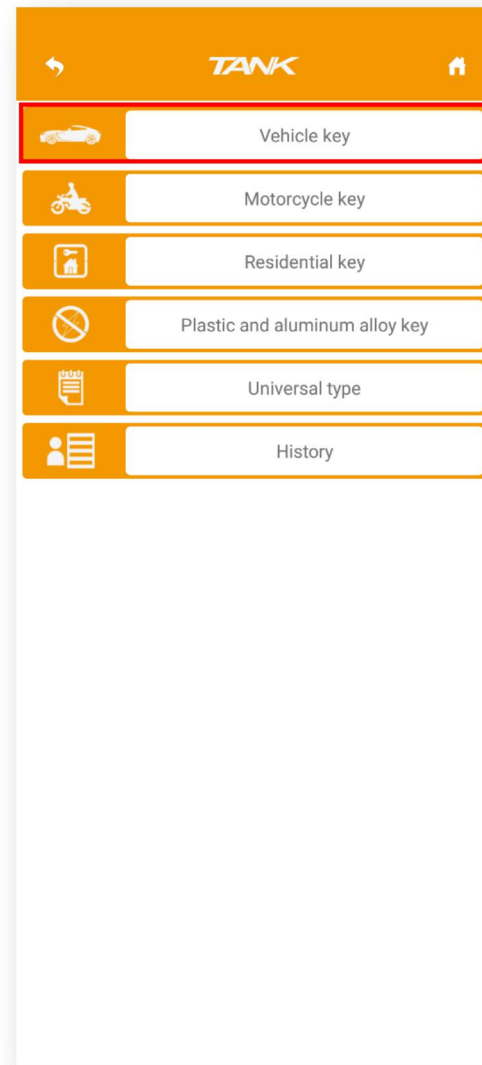

Click “Vehicle key”

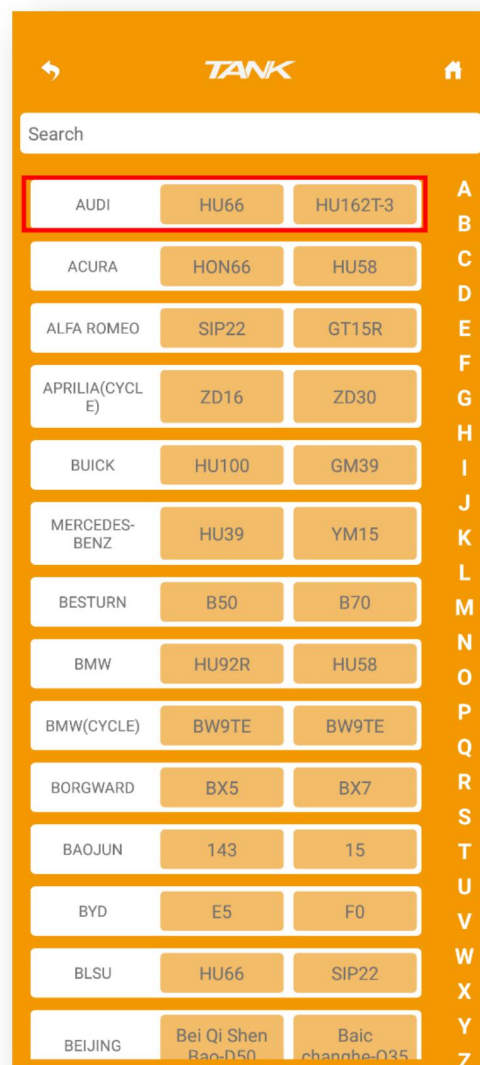

Select vehicle



Select car Series

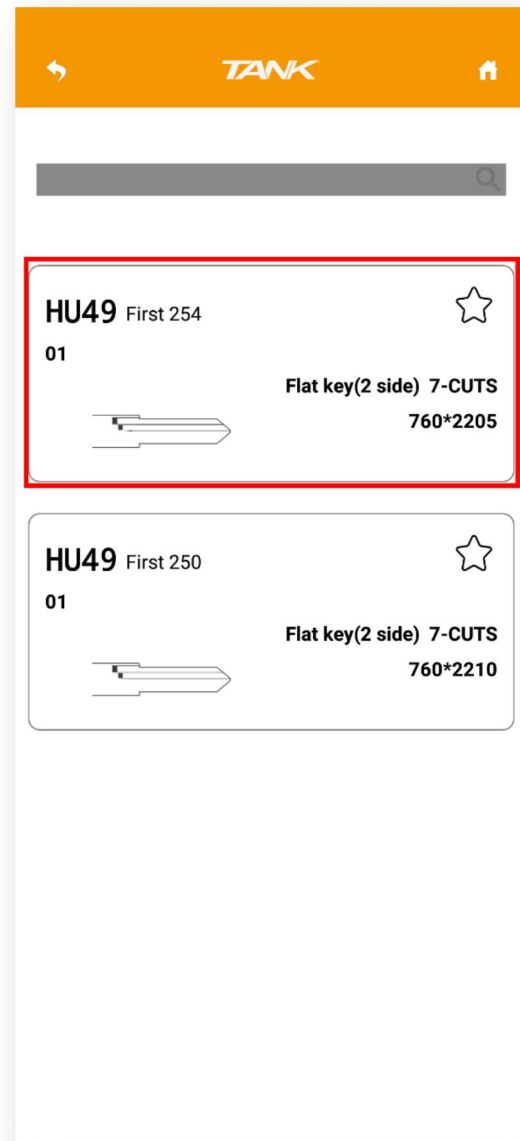

Select key

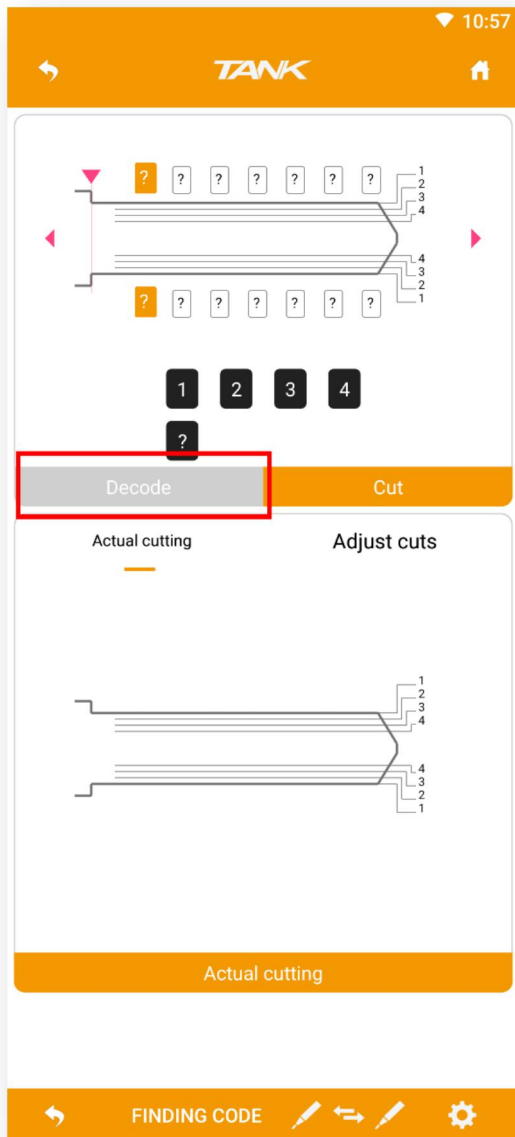

Click "decode"

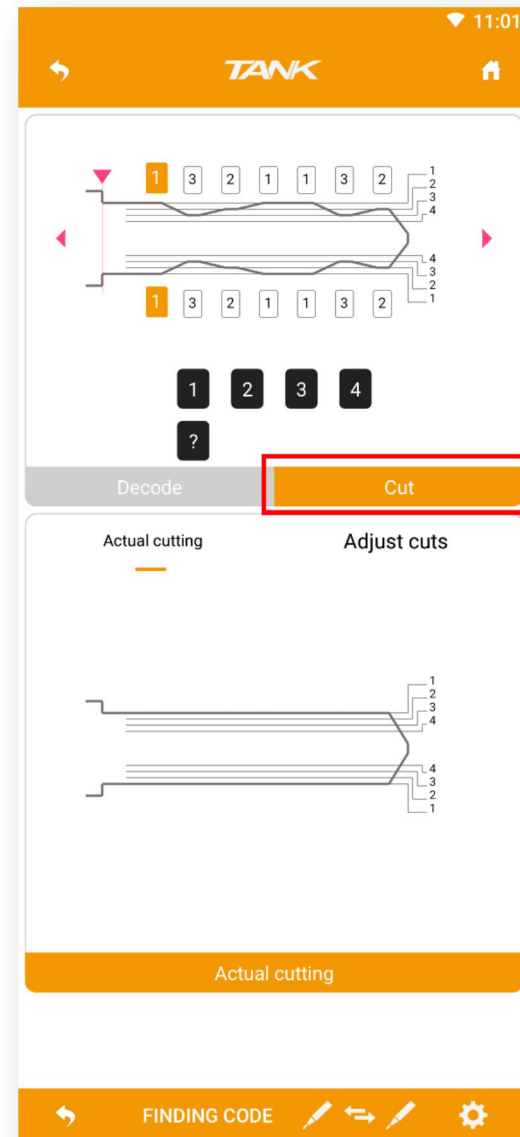

Click "cut"

*Operation depend on App guide

6-5 How to use all key lost

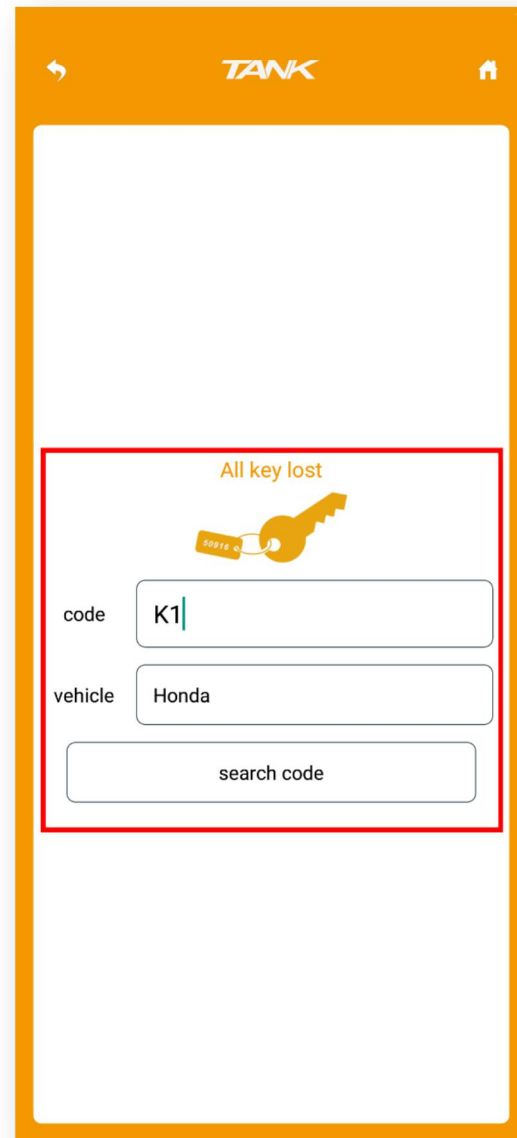
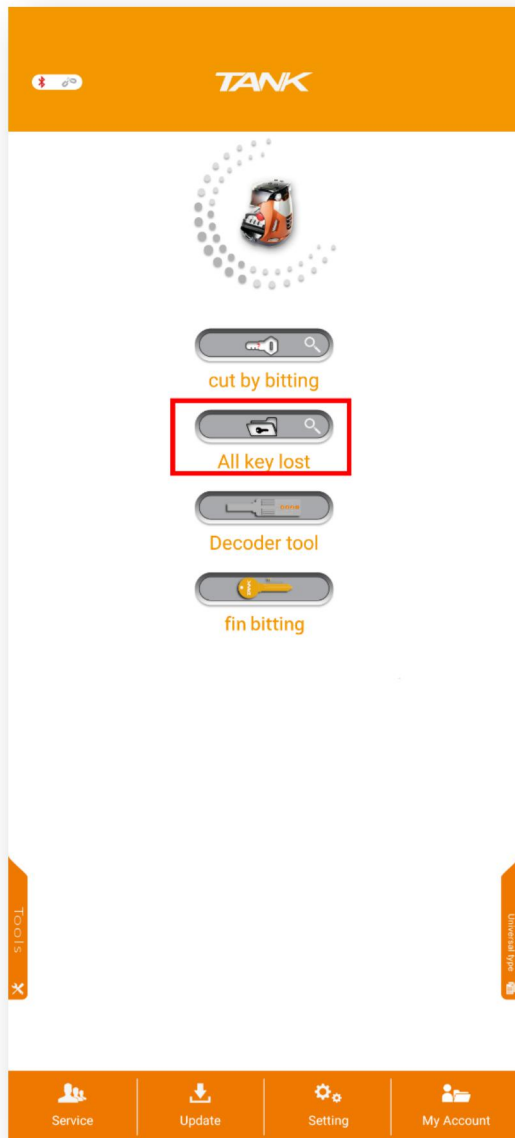

Enter 2M2 TANK main interface, select “all key lost”

Input lock number and vehicle

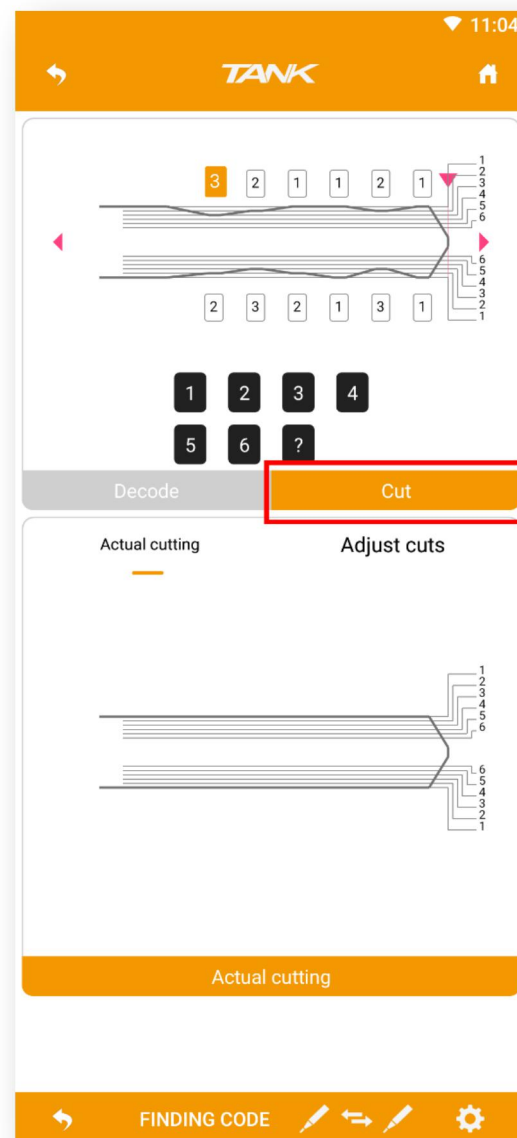
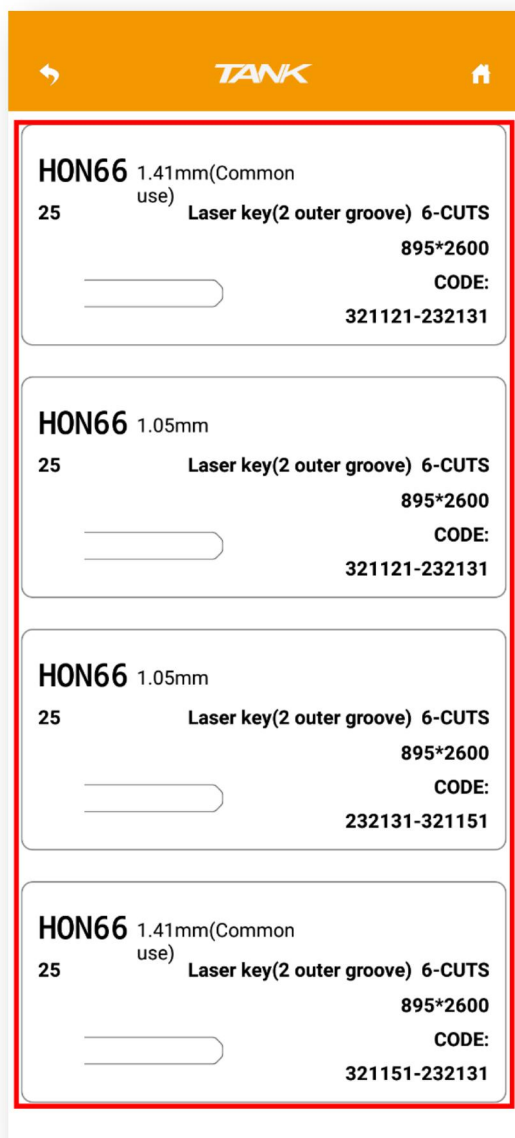

Select right one depend on the list.

Please click “cut”

*Operation depend on App guide

6-6 How to use find bitting

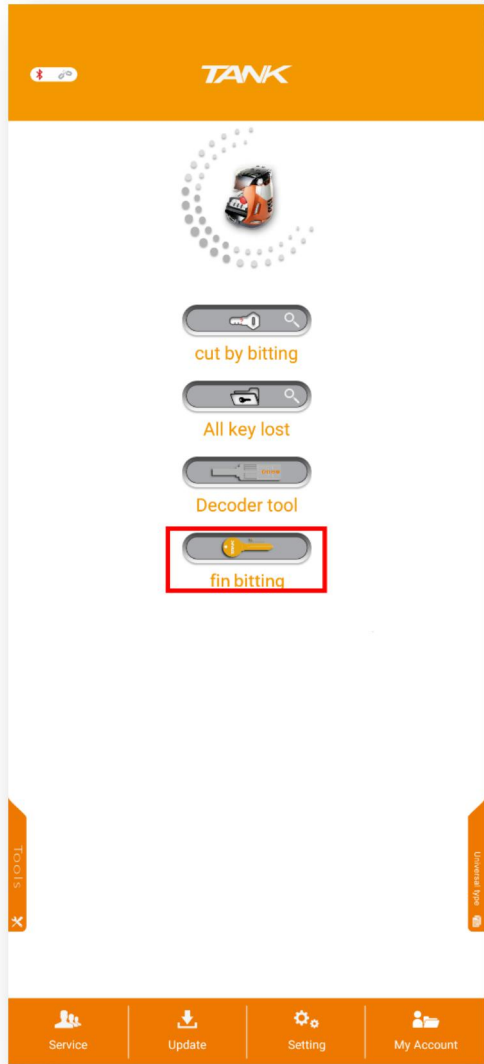

Click “find bitting”



Select vehicle



Select vehicle

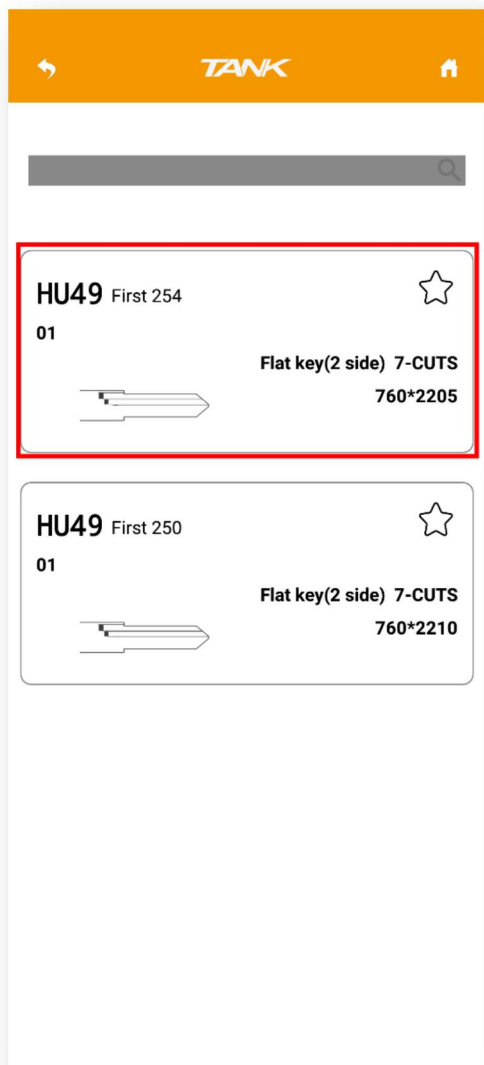

Select key

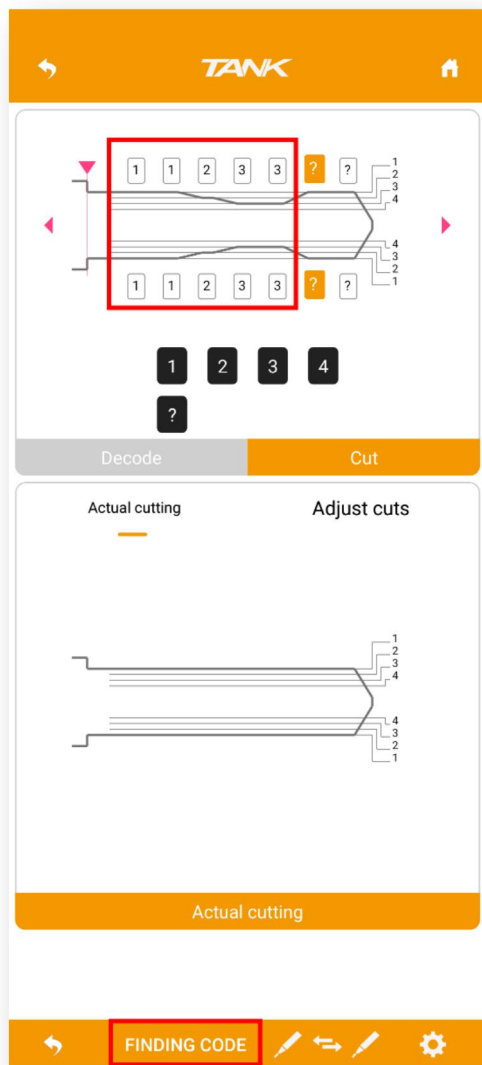

Input key cuts that it already had



Select the right cut number in

*Operation depend on App guide

7、How to use universal key duplicate

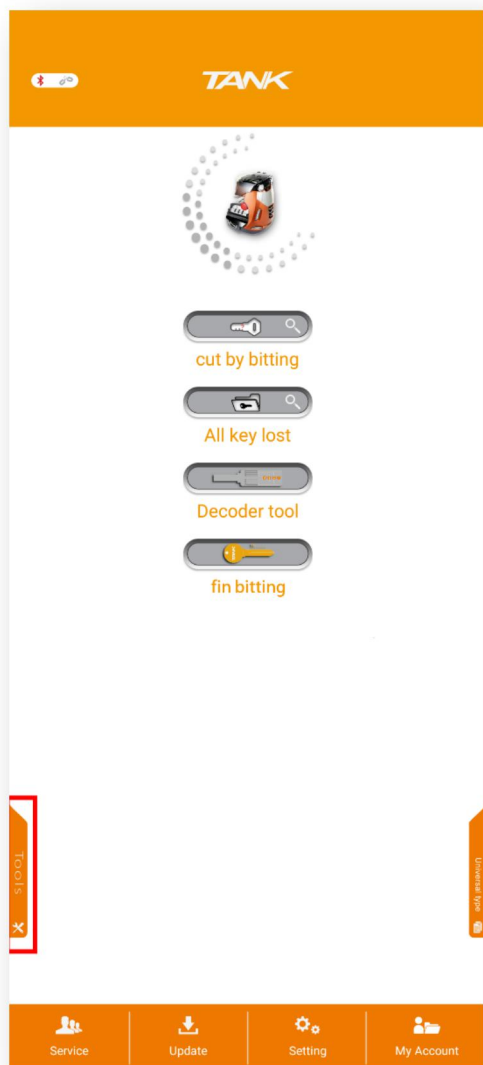

Click "tools"

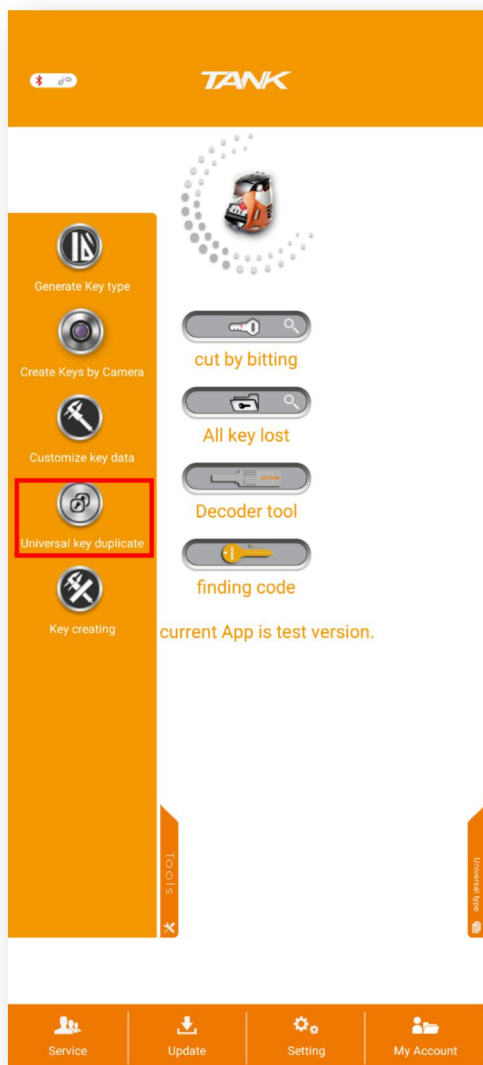

Click "universal key duplicate"

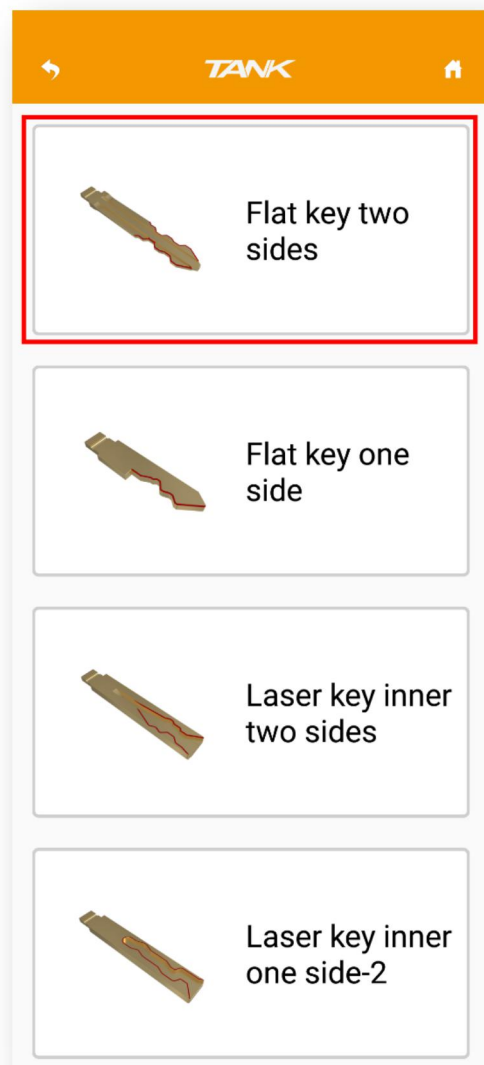

Select key type

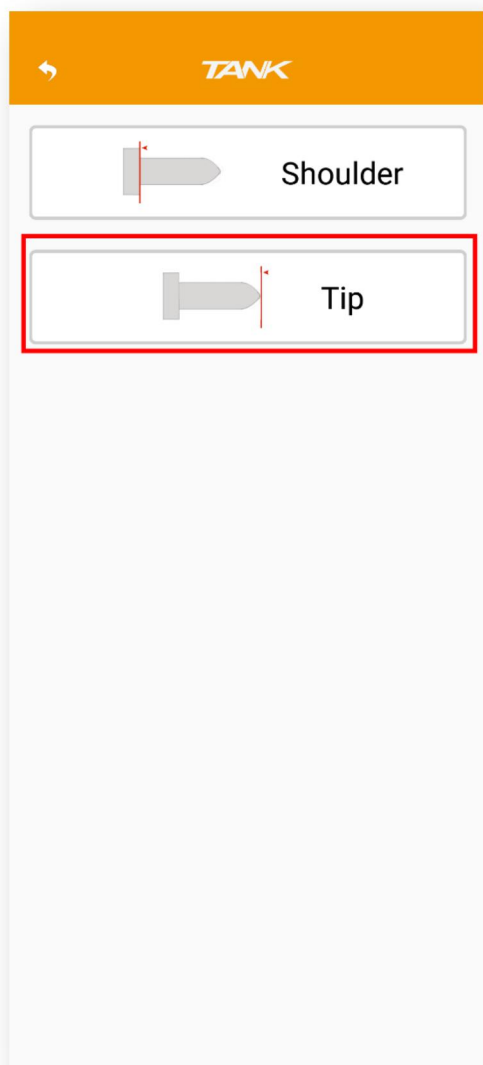

Select way of alignment

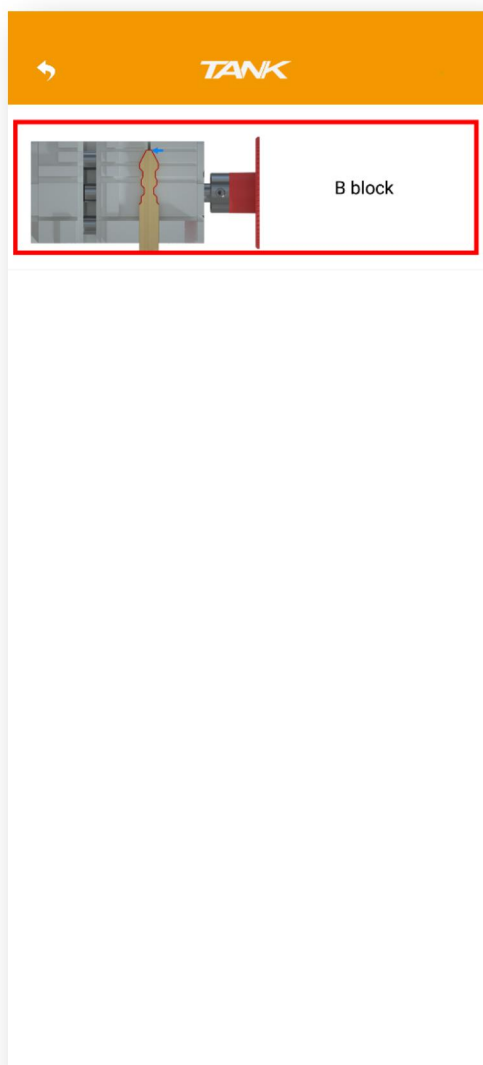

Select way of installation

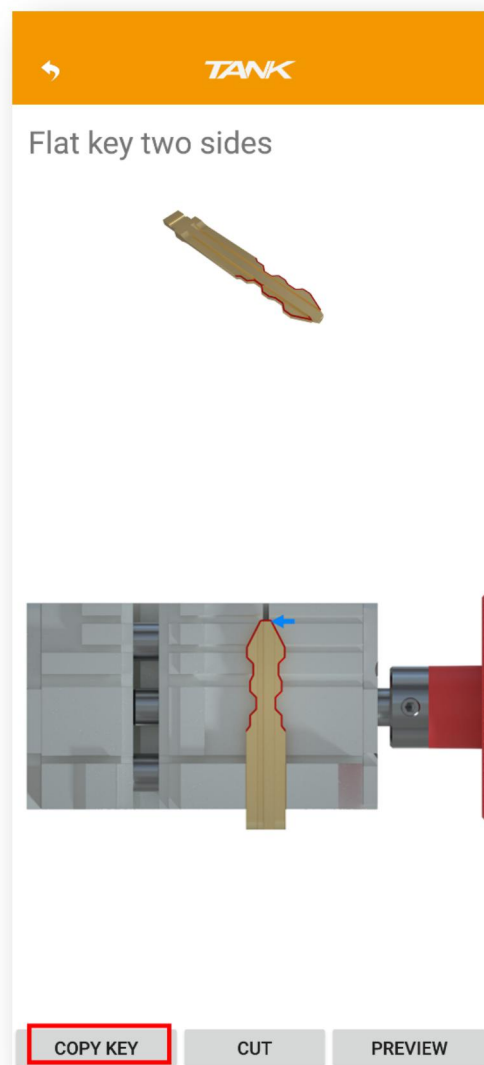

Click "copy key"

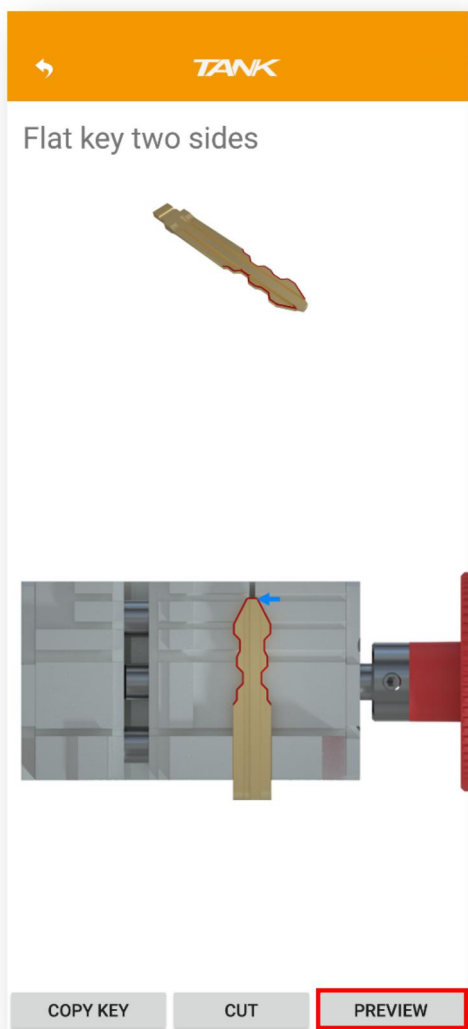

Select preview

cut without preview) (Preview is to judge

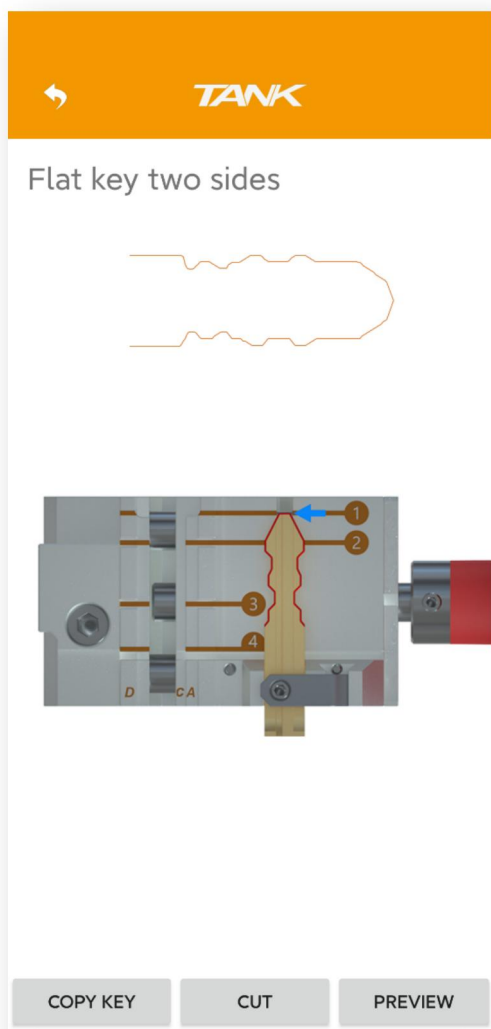

It will appear key shape

correction of the key)

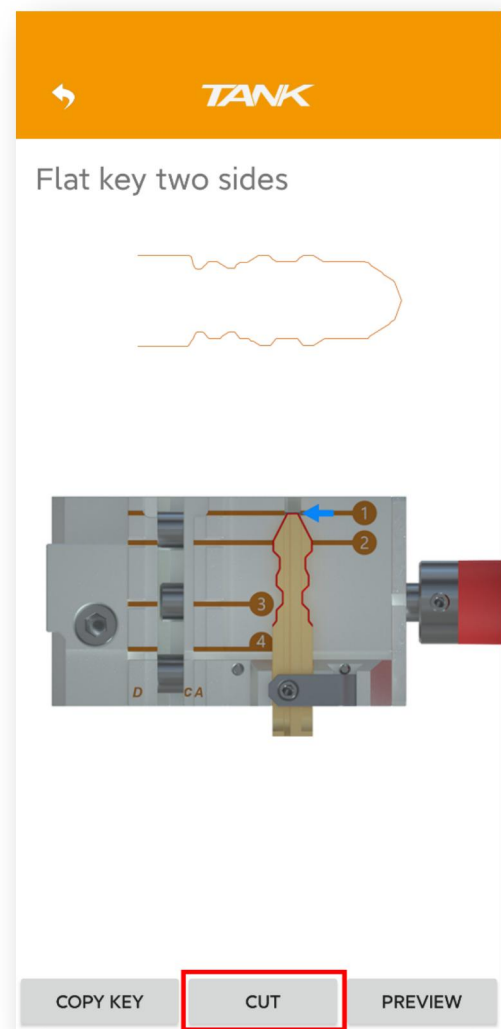

Select 'cut' after copy (Directly

***Operation depend on App guide**

8、How to use generate key type

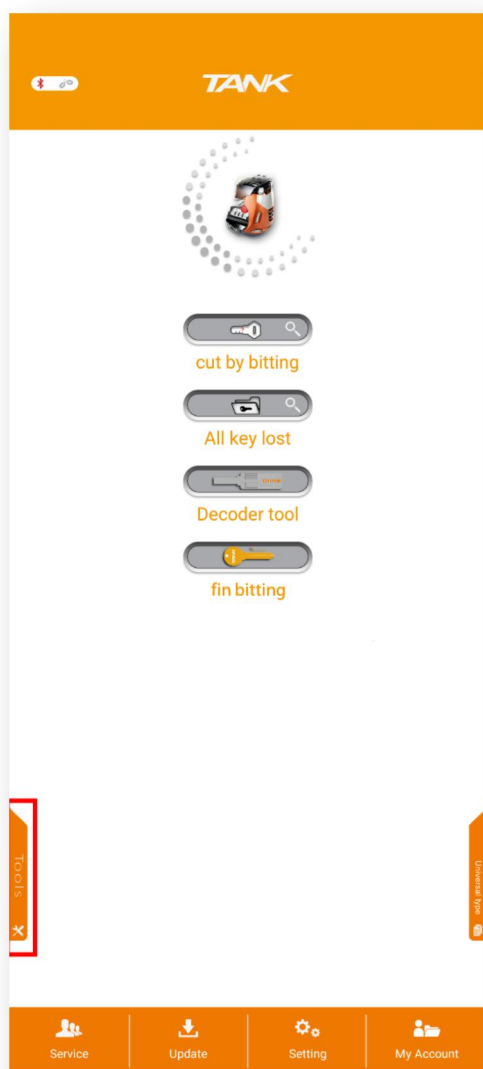

Select 'tools'

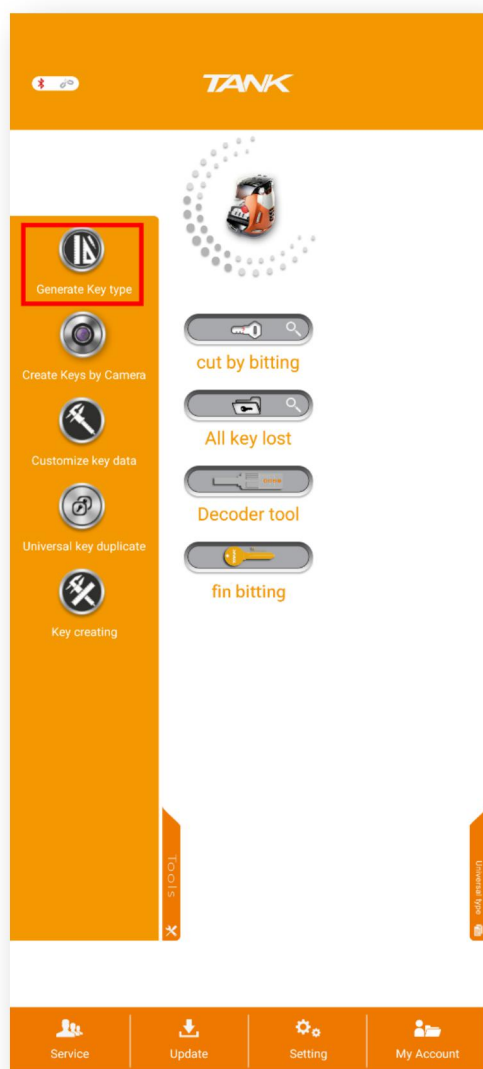

Select 'generate key type'

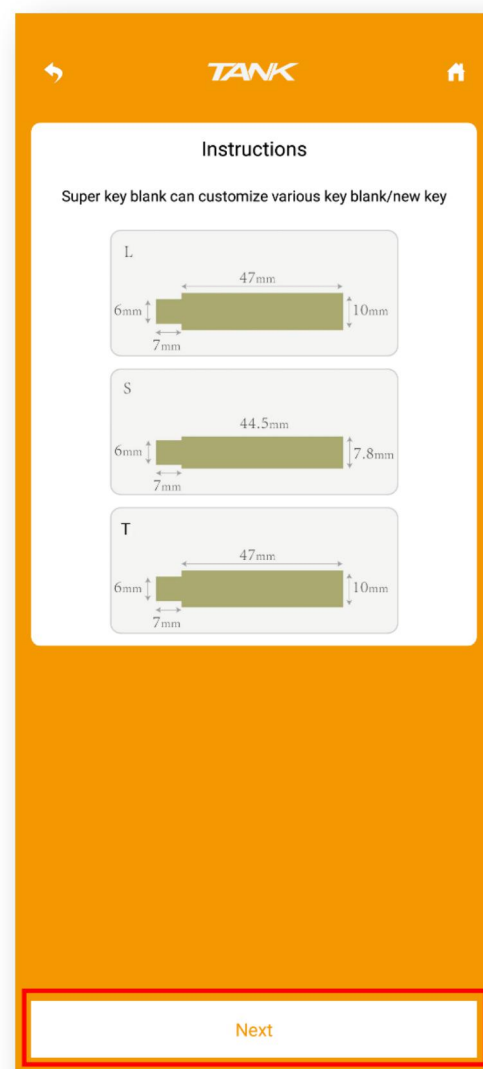

Super key blank instruction

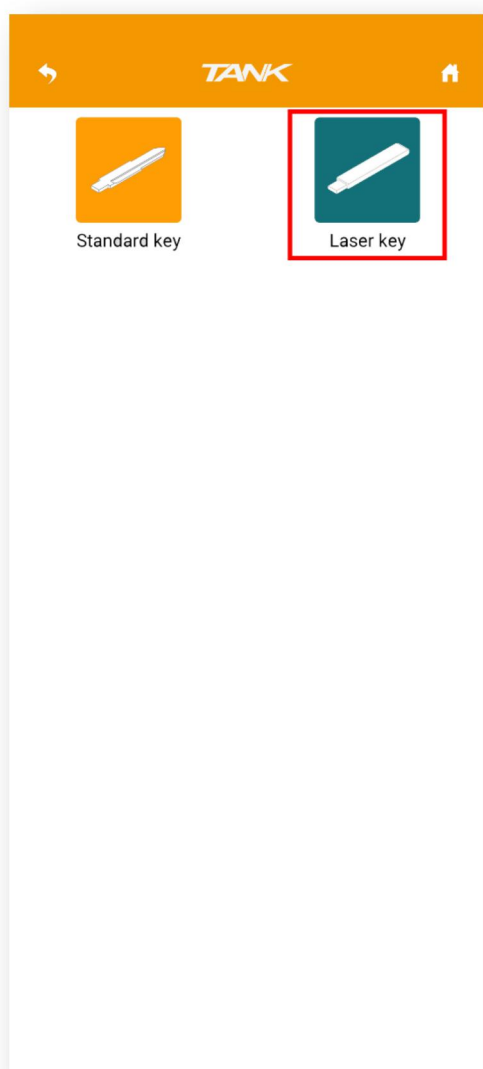

Select 'key type'

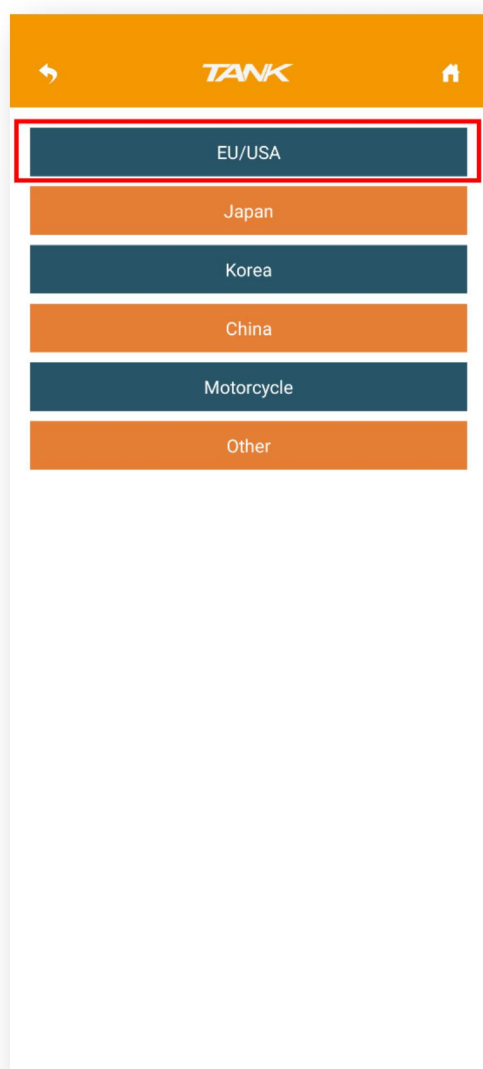

Select 'country'

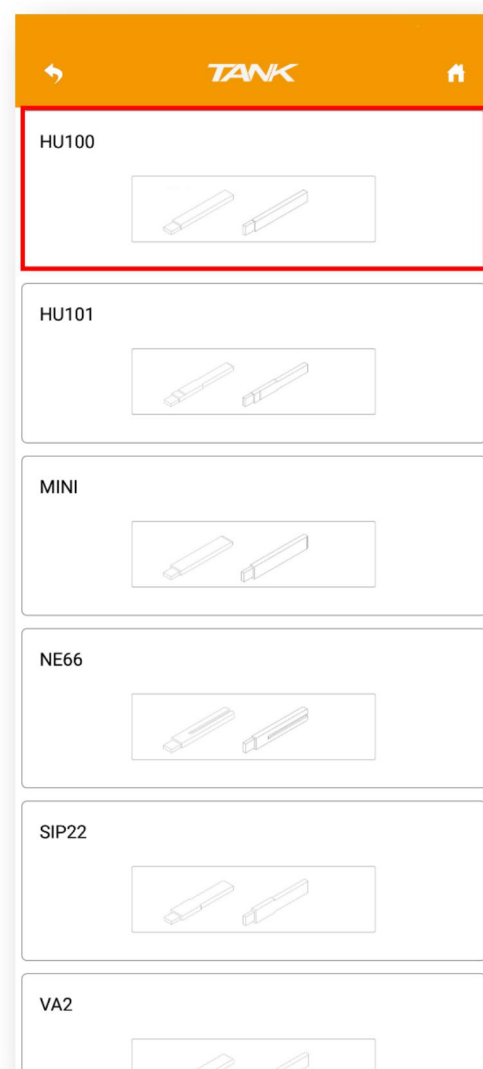

Select key blank that you need

(*notes: This function just generate key blank, Operation depend on App guide)

9、How to use customize key type

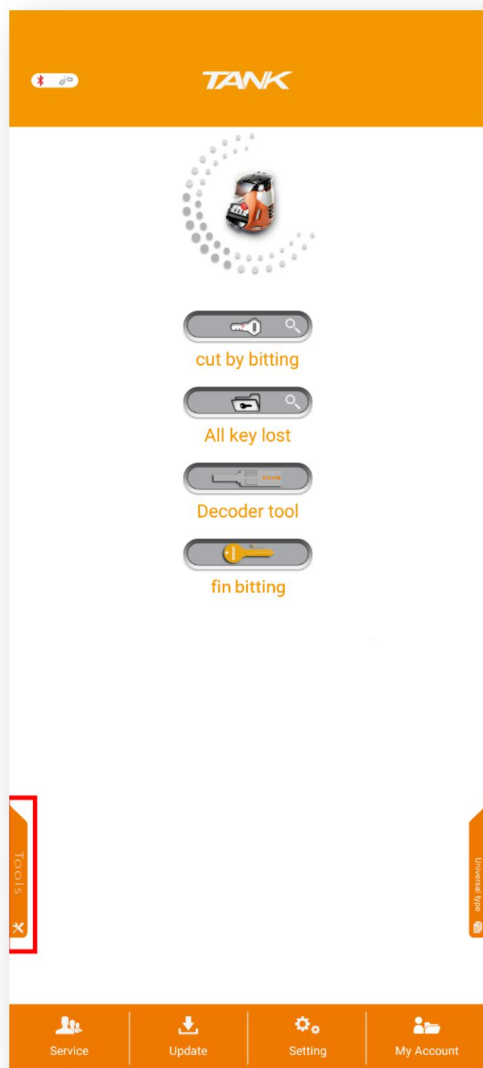

Select 'tools'



Select 'customize key data'

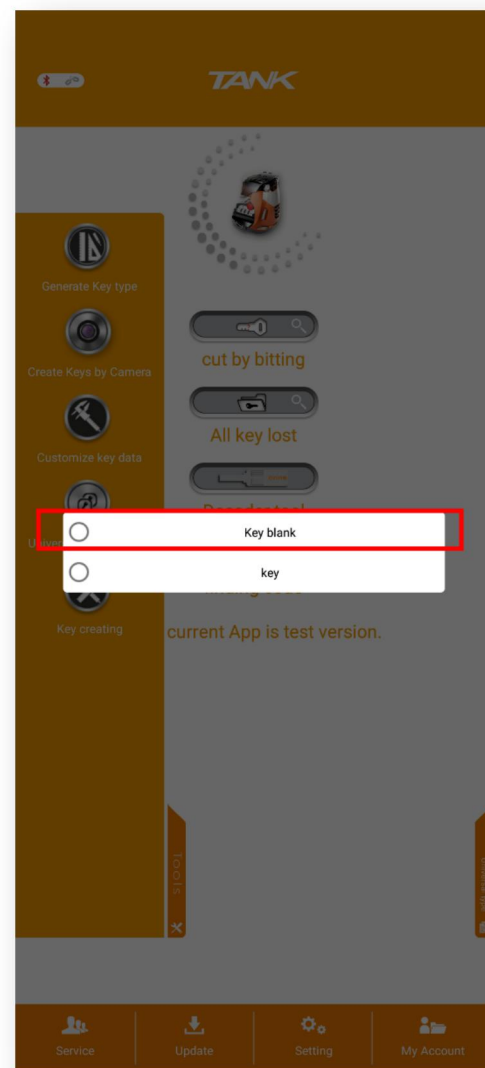

Select 'key blank'

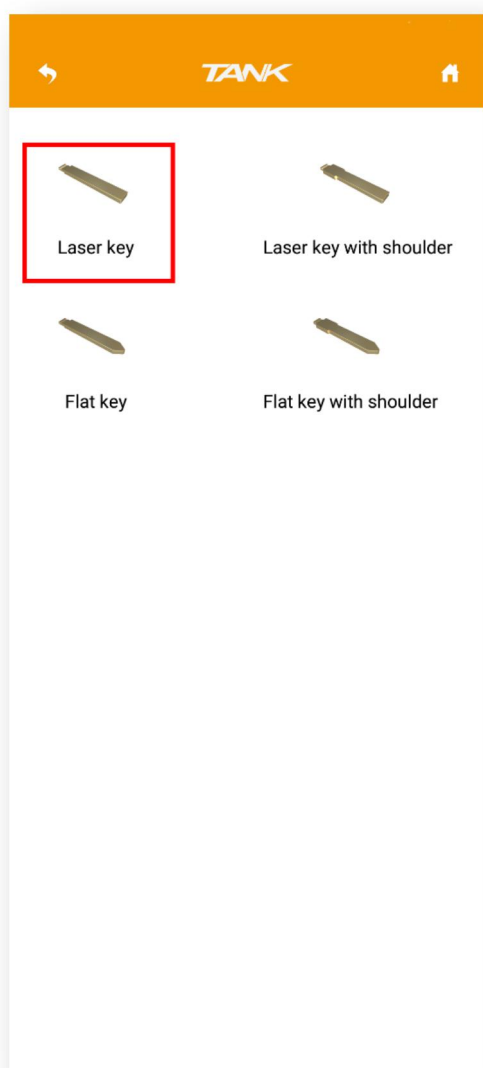

Select key type

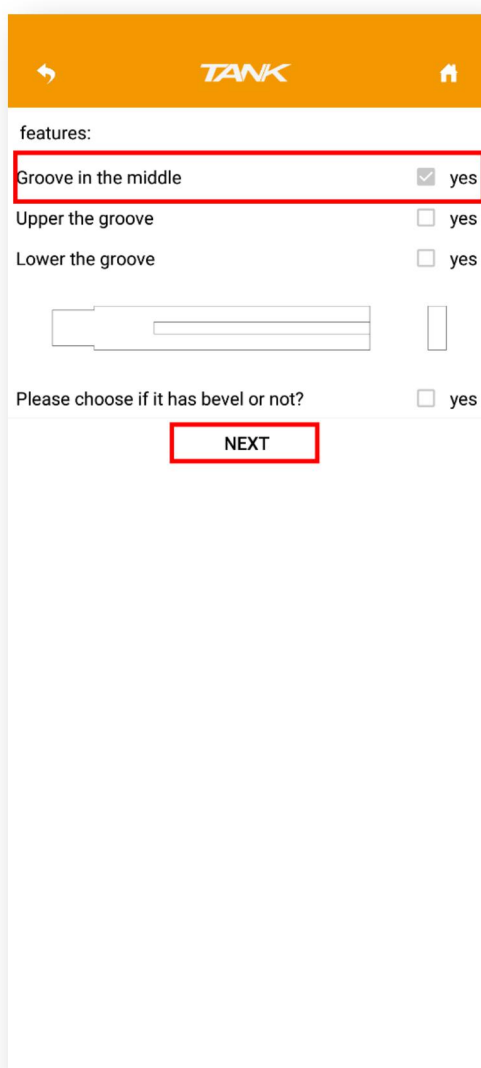

Select features

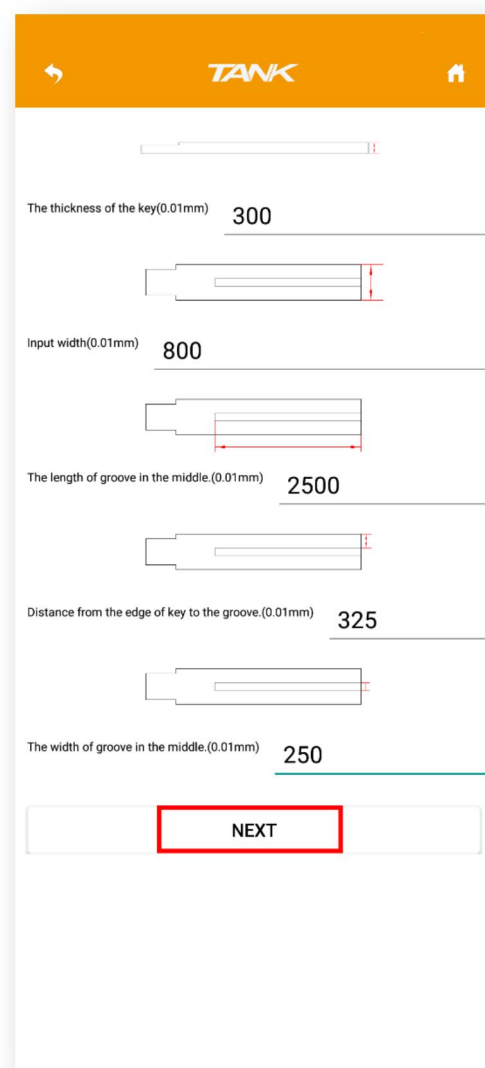

Input data and click 'next'

(注意所填数据单位为: 0.01mm)

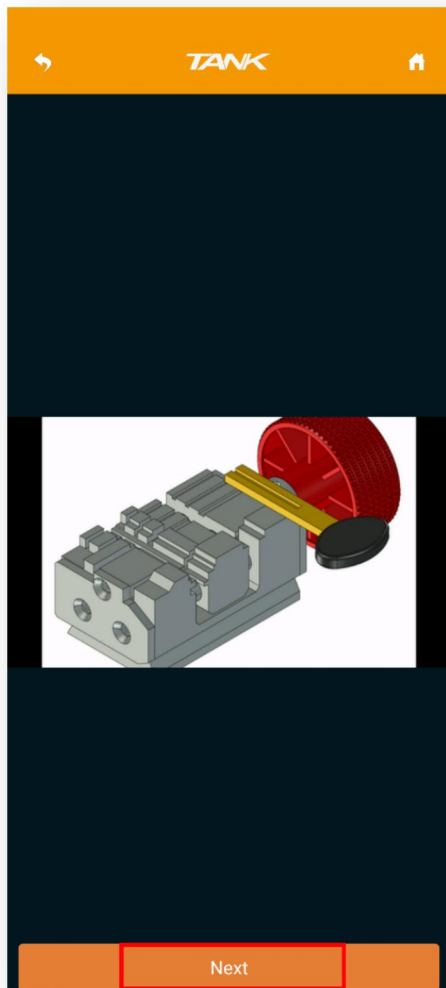

Installation animation

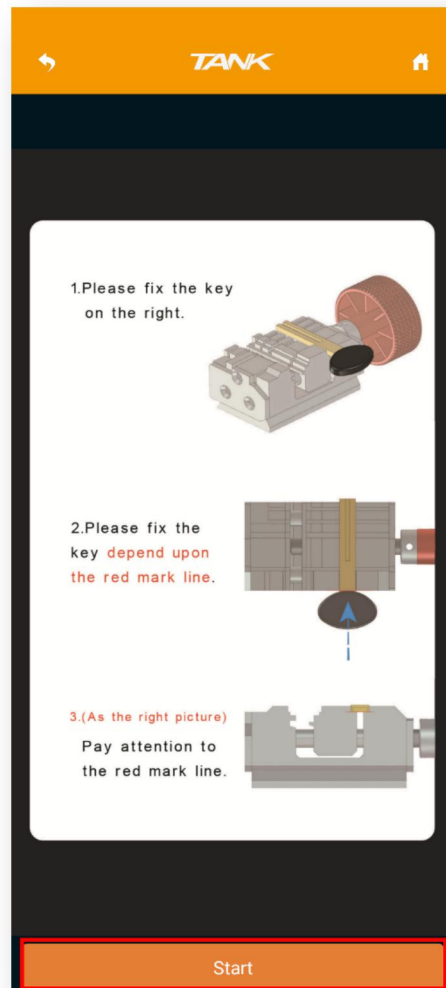

Install key depend on the picture



It' s working,please wait.

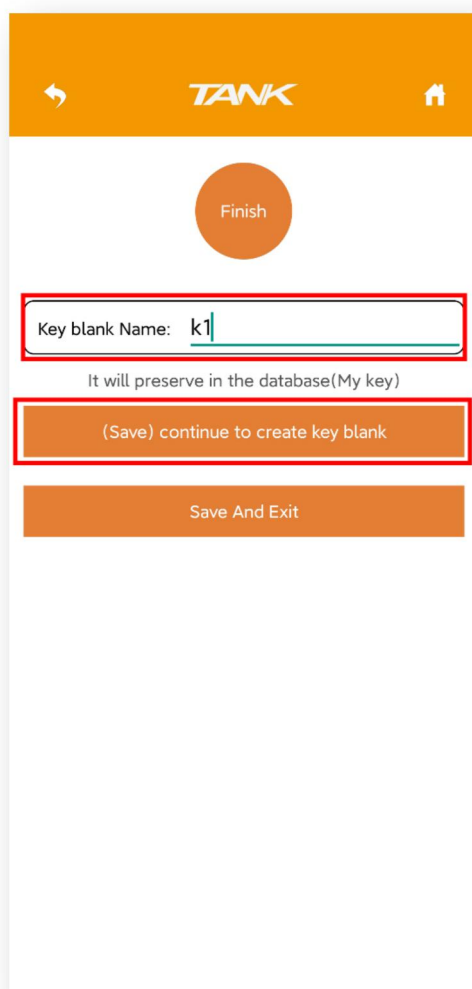

Name the key blank and save and exit
Compare with installation a new key blank

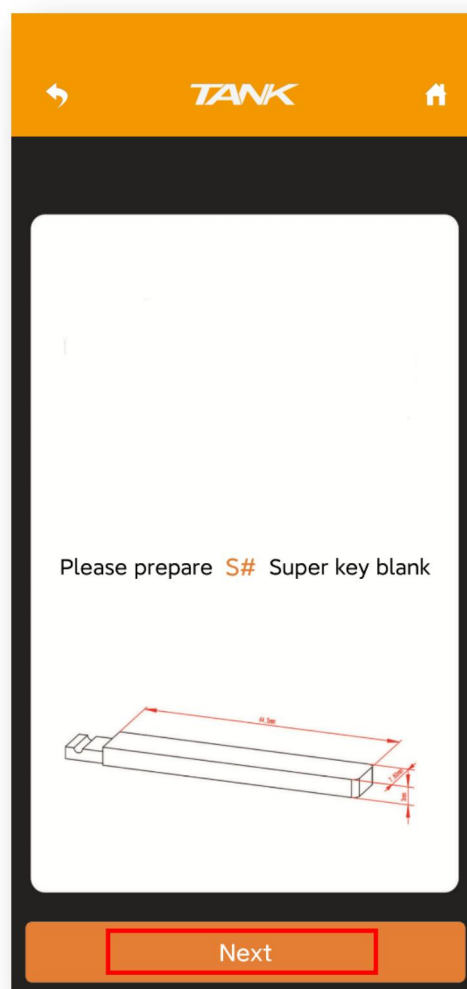

Select super key blank
and then click 'next'

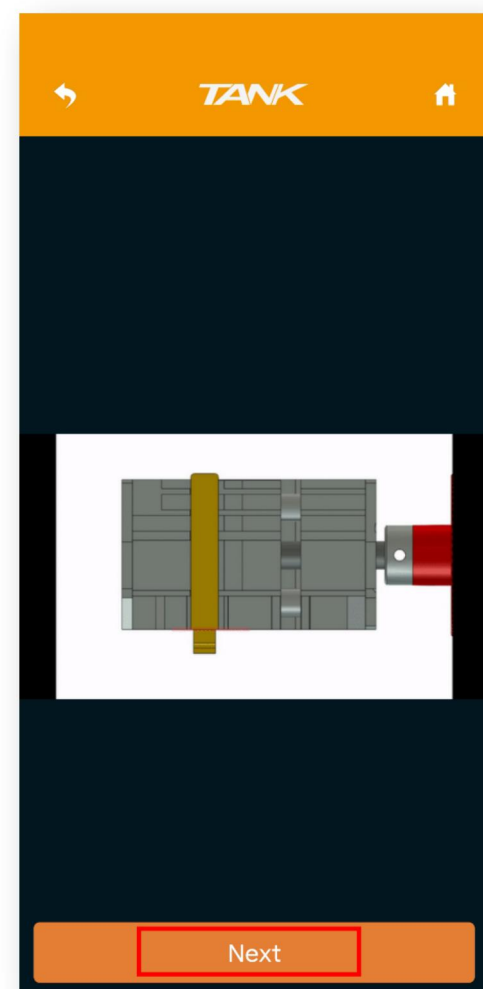

Compare with installation
and click 'next'

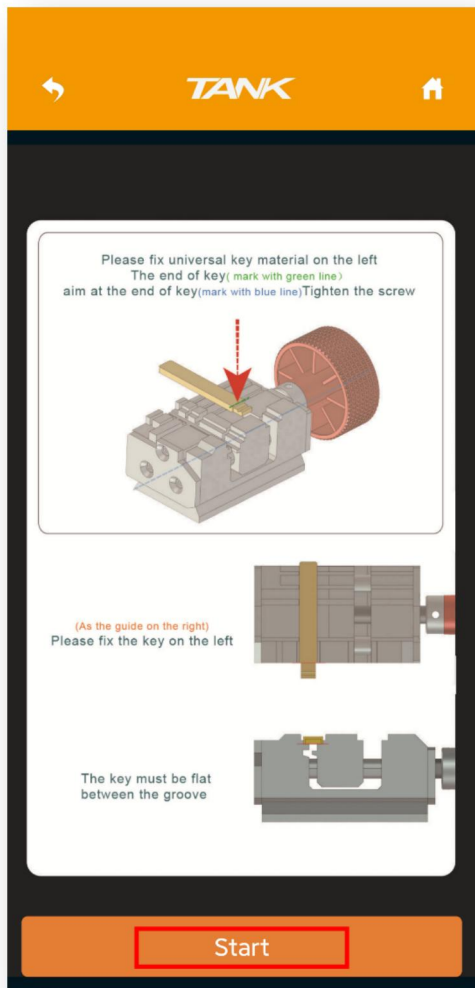

Install super key blank and click 'start'



It's working, please wait.

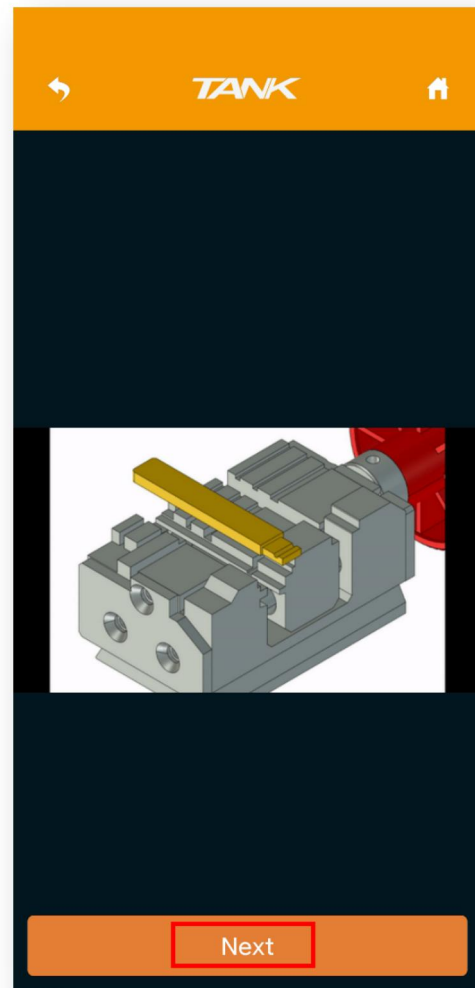

Click 'next'

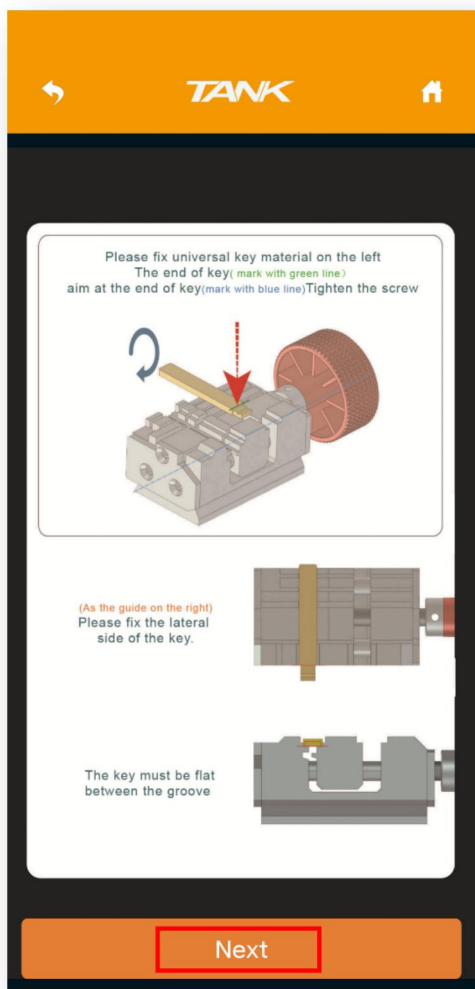

Install super key blank and click 'next'



It's cutting the other side, please wait.

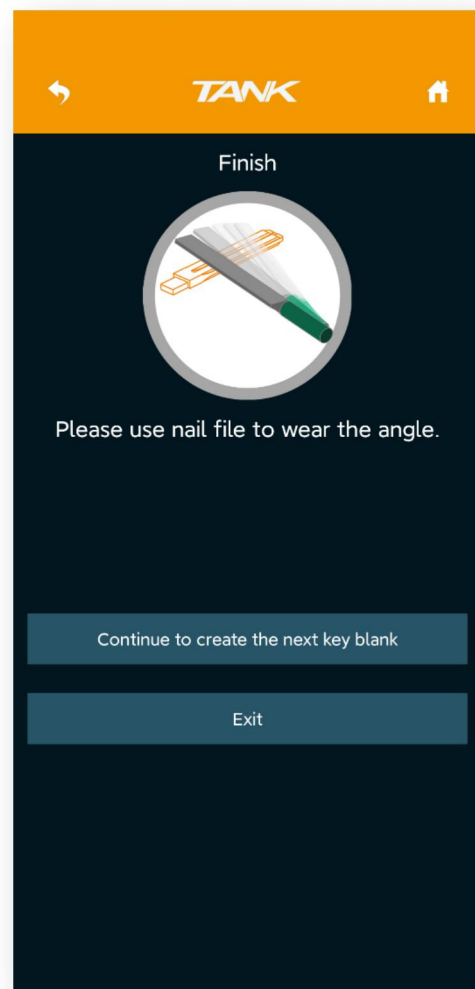

Continue to create another one or exit.

10、 How to use customize key data

(Laser key as a sample)

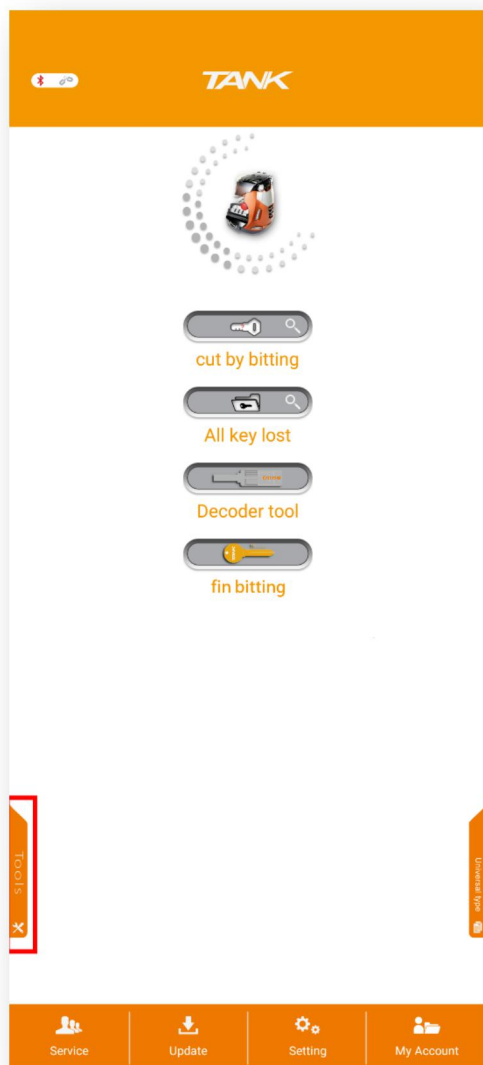

Select 'tools'

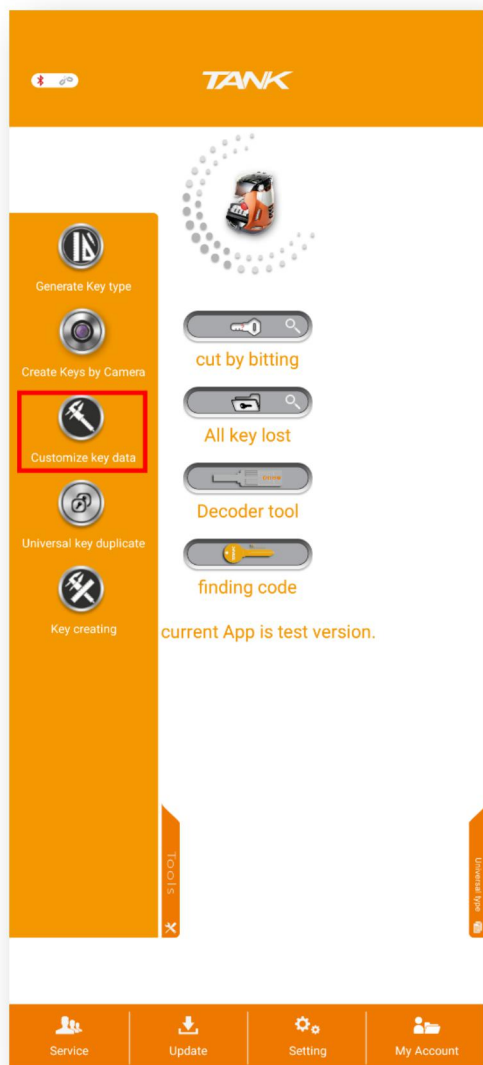

Select 'customize key data'

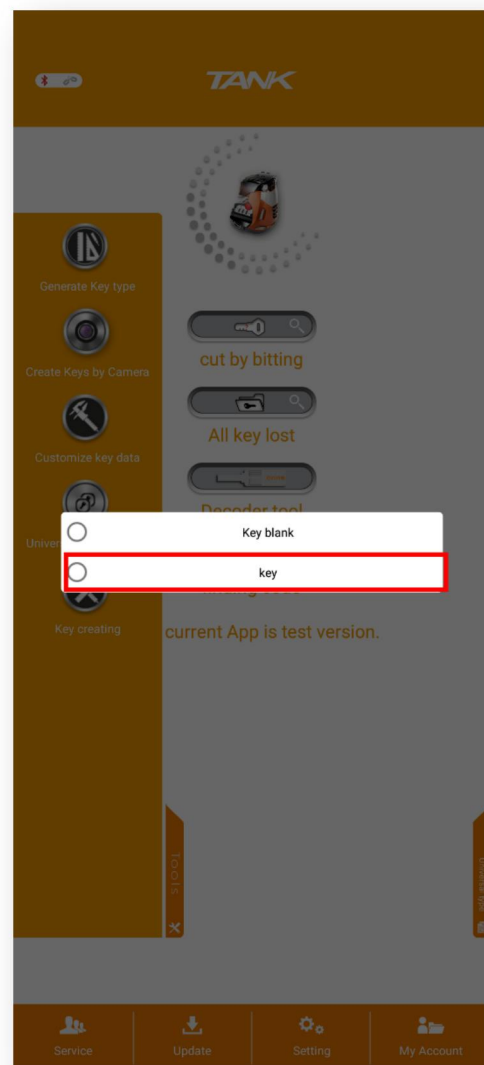

Select 'key'

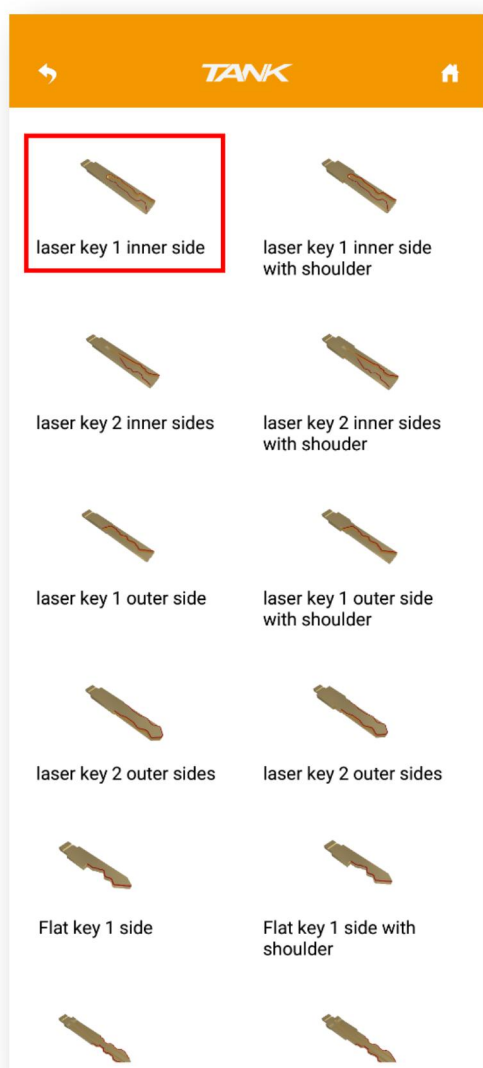

Select key type

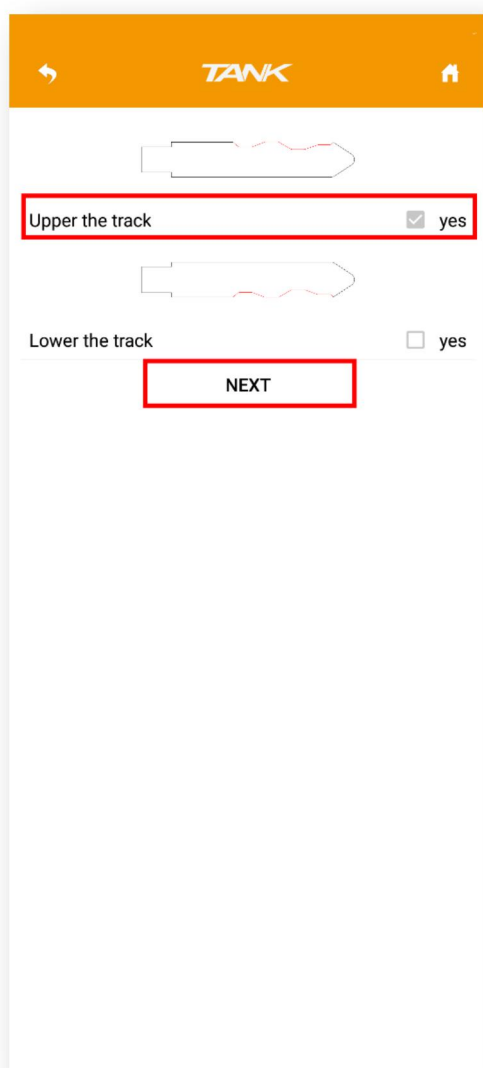

Select groove position

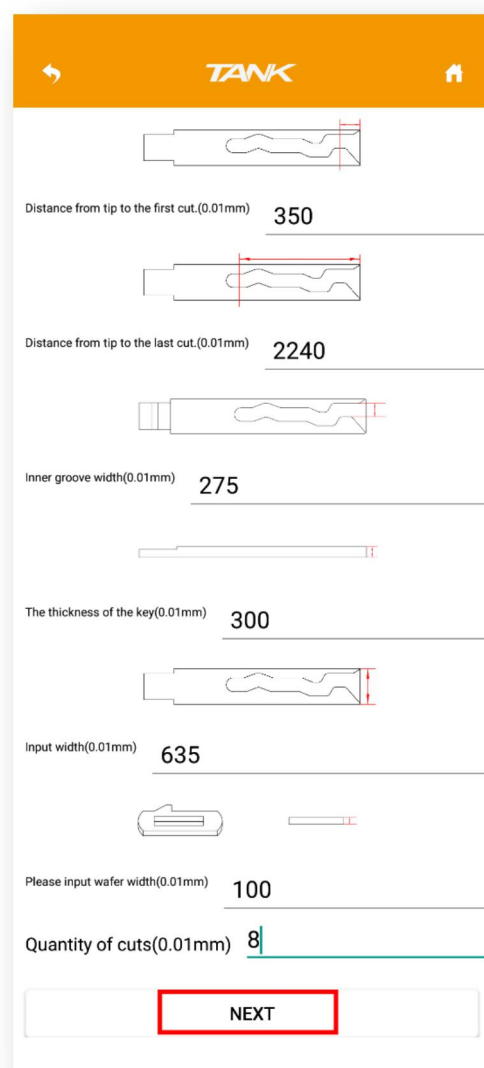

Input data by measuring and click 'next'

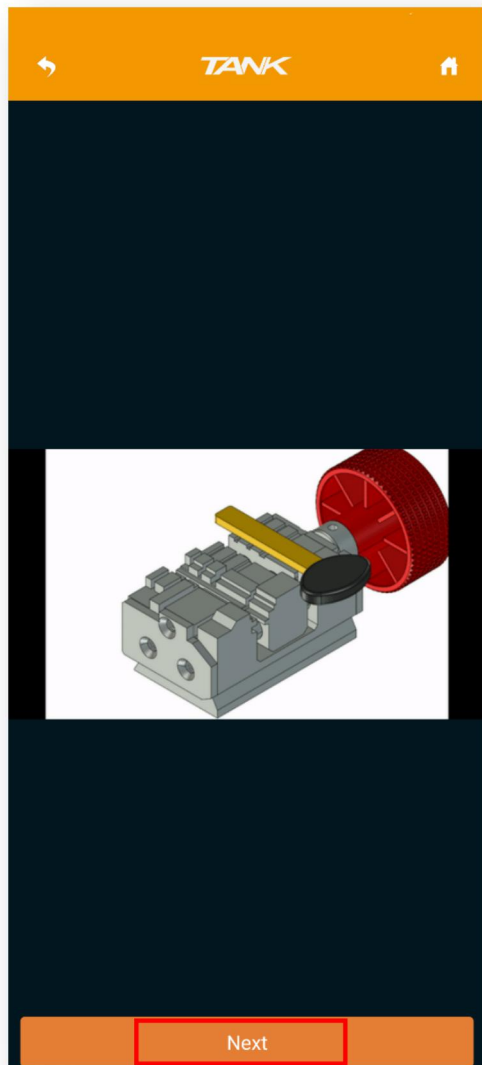

Installation animation

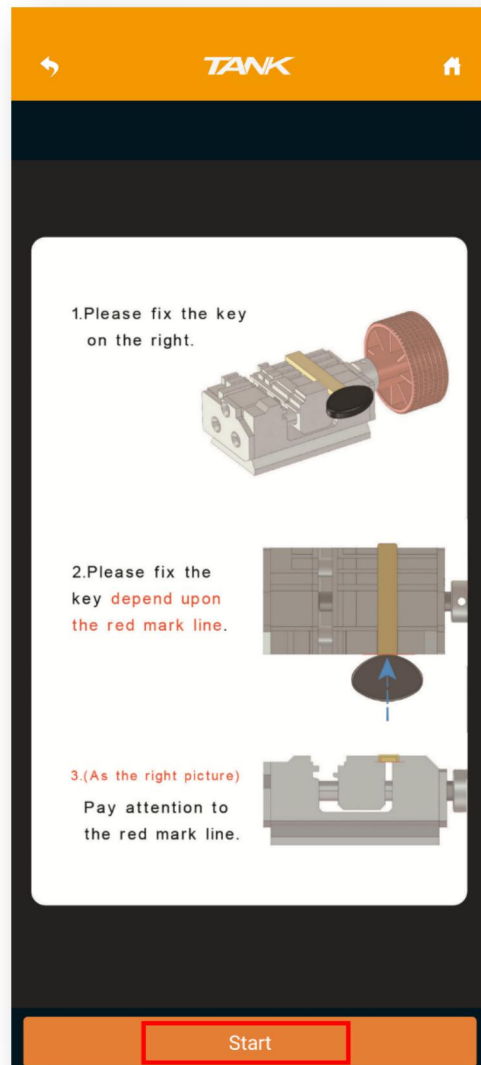

Install the key and click 'start'

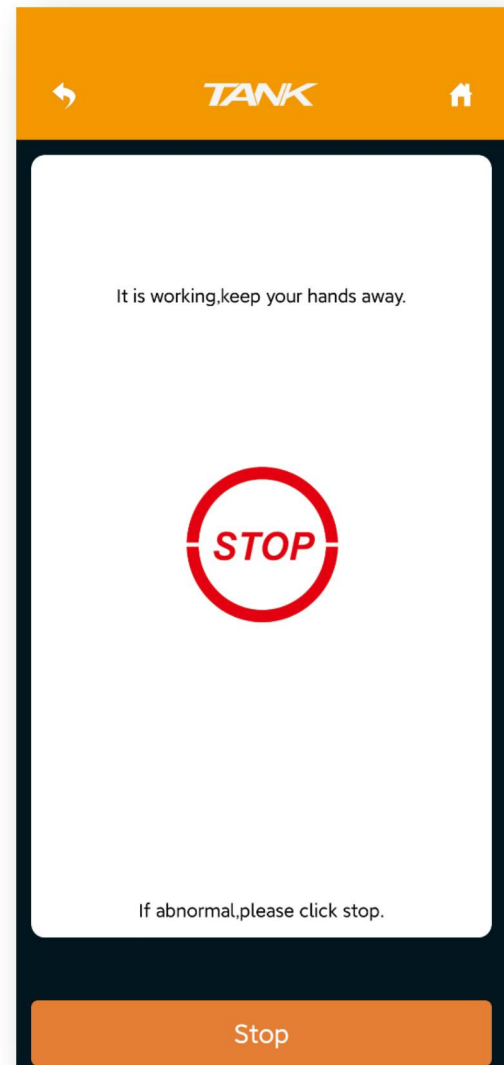

It's working, please wait.

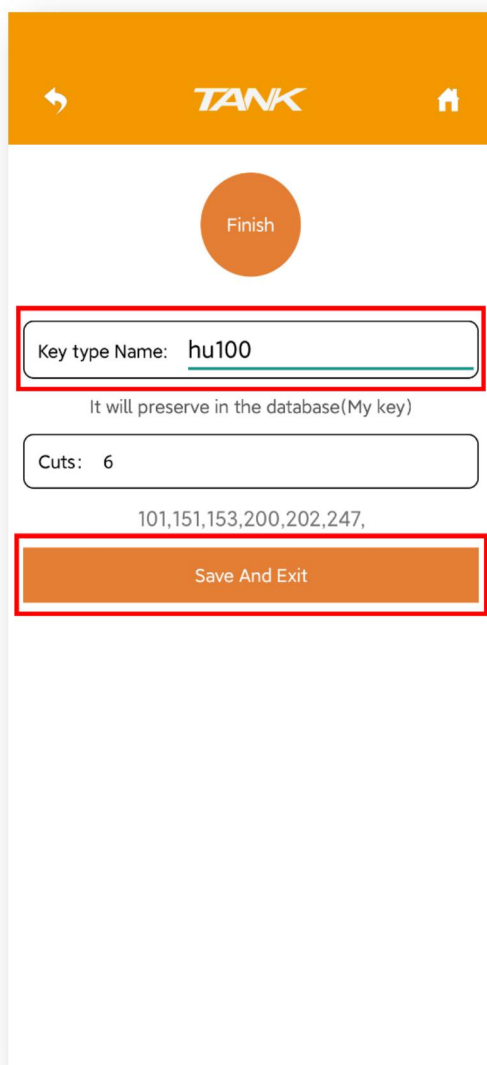

Name the key and

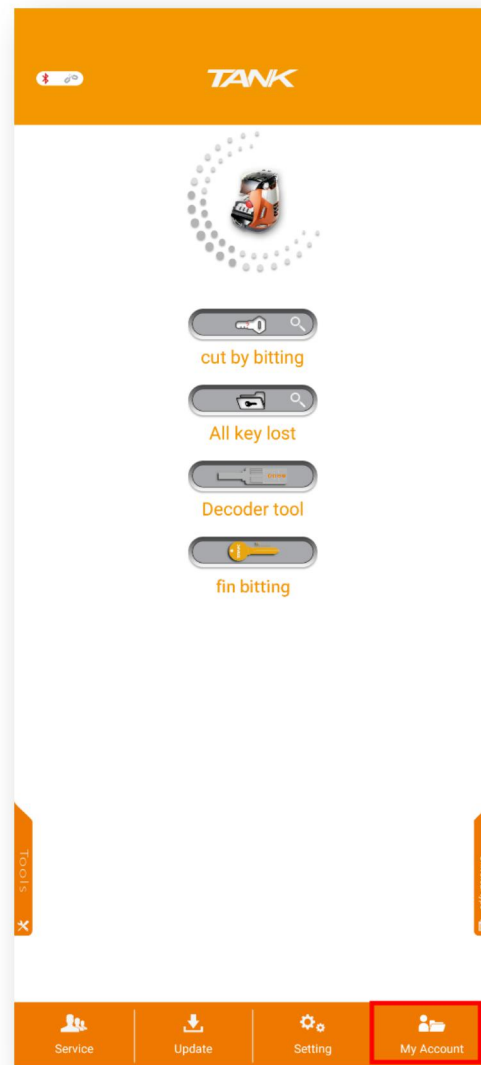

Click 'My account'

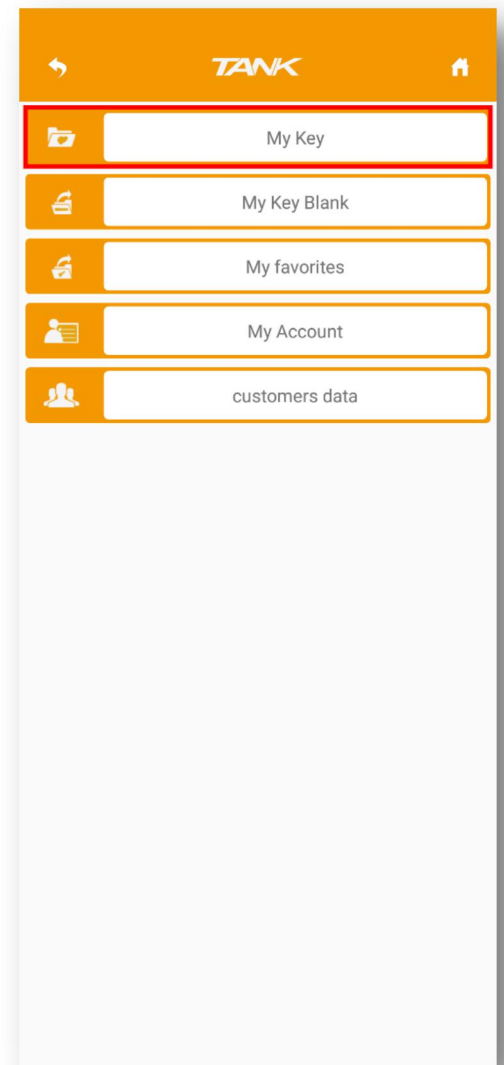

Click 'my key' Save and exit

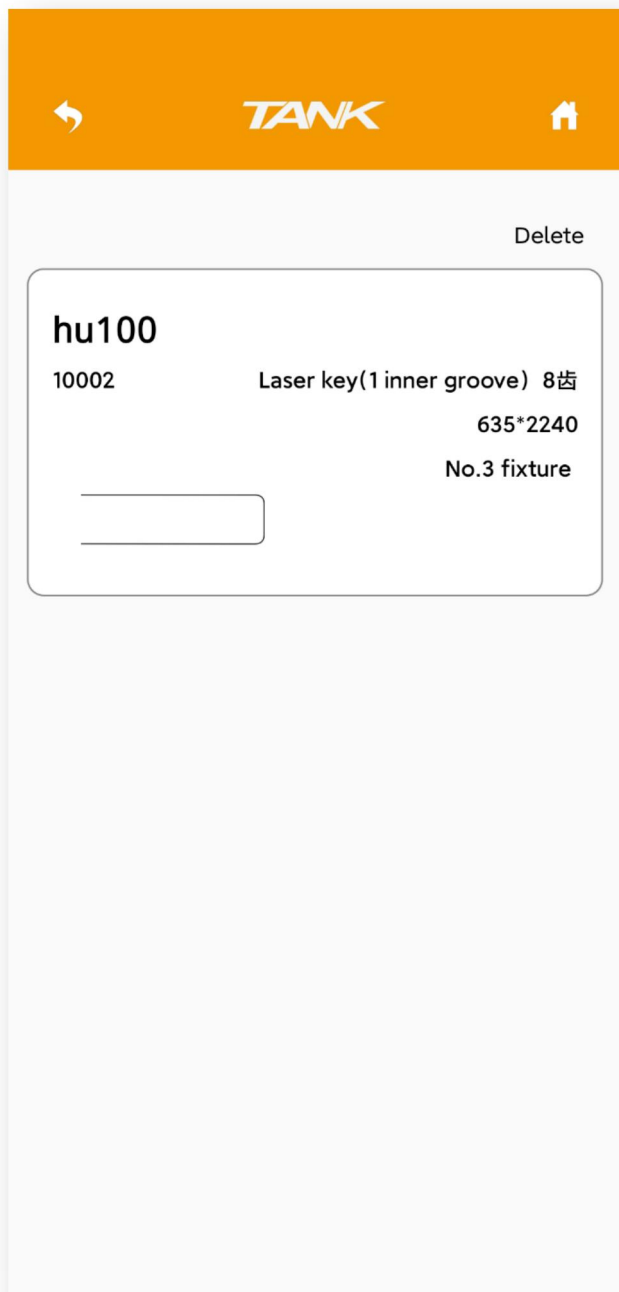

Click the key that you create

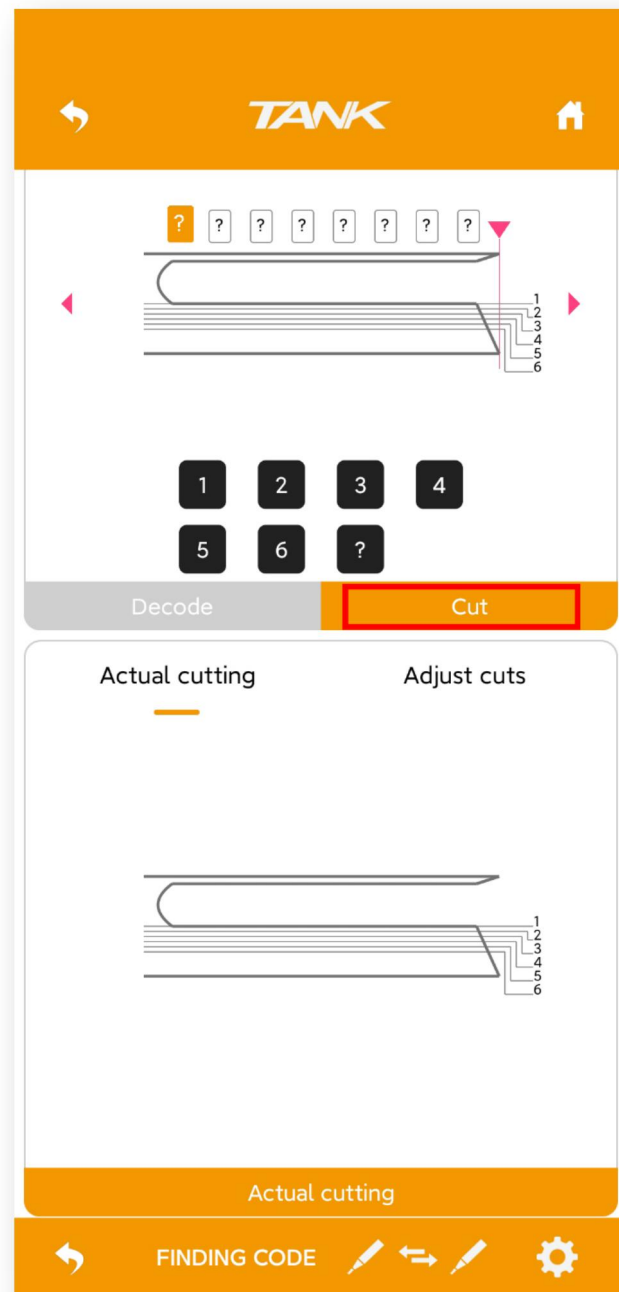

Click 'cut'

***Operation depend on App guide**

11、Decoder tool

It's convenient for locksmiths to transform cuts after decoding via this function.

11-1 How to use decoder tool

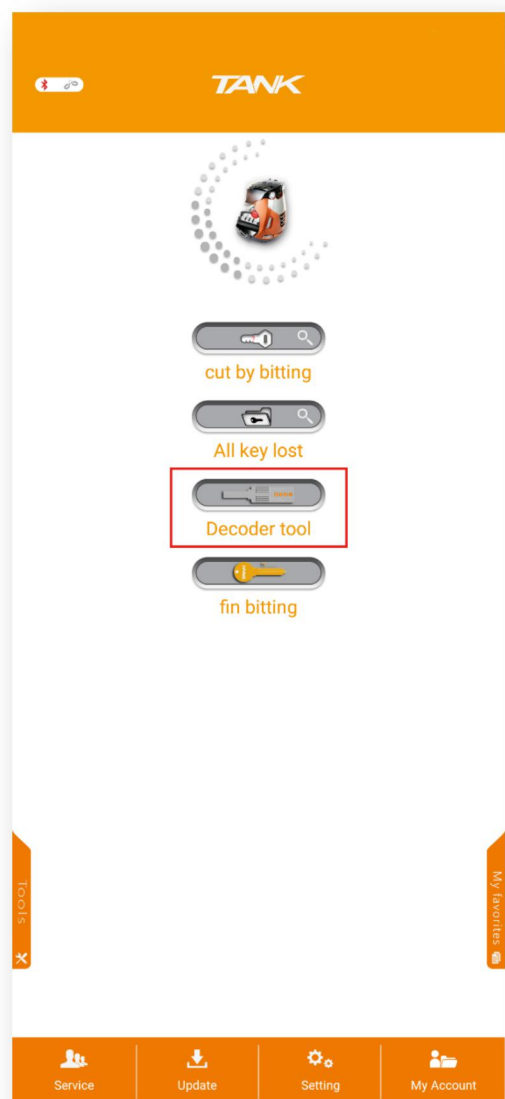

Select 'decoder tool'

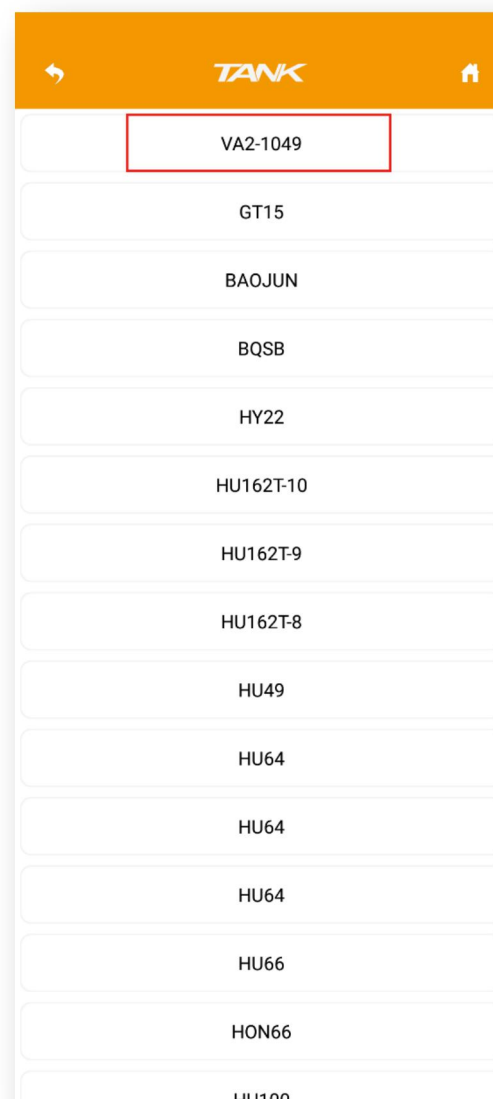

Select key type that corresponds with

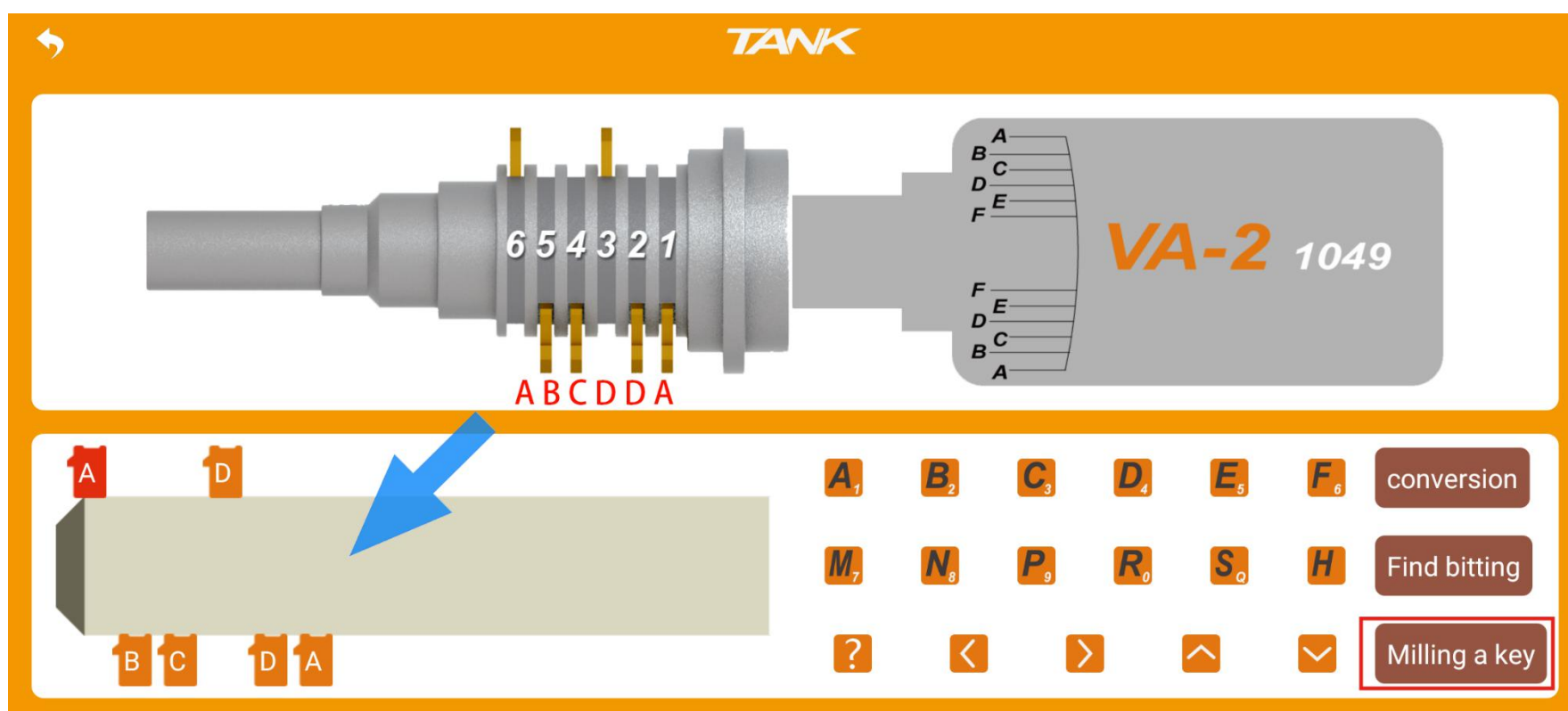

Input the cuts that you decode into the space, and then click 'key cut'.

Notes: If the cuts that need to transform, Click 'transform'.

11-2 How to find bitting via decoder tool

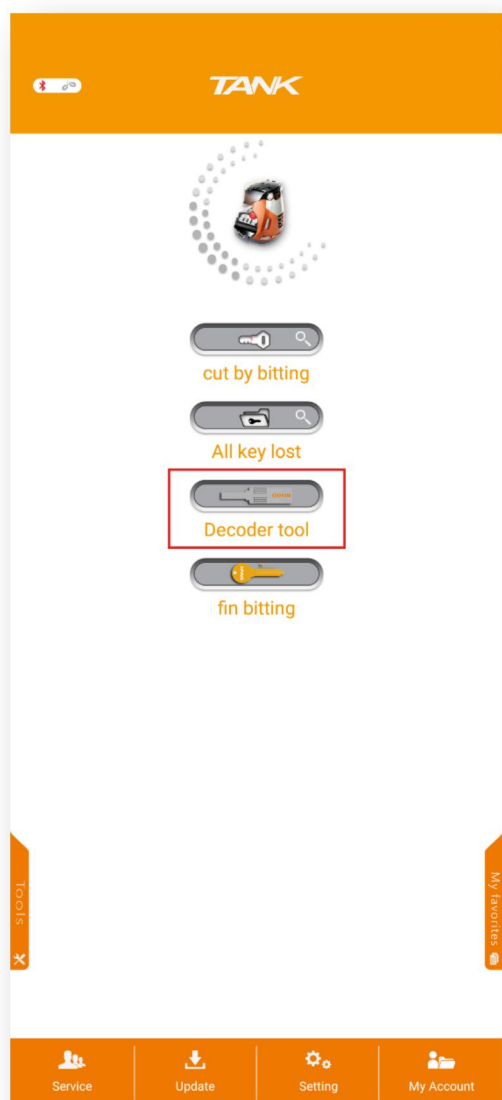

Select 'decoder tool'

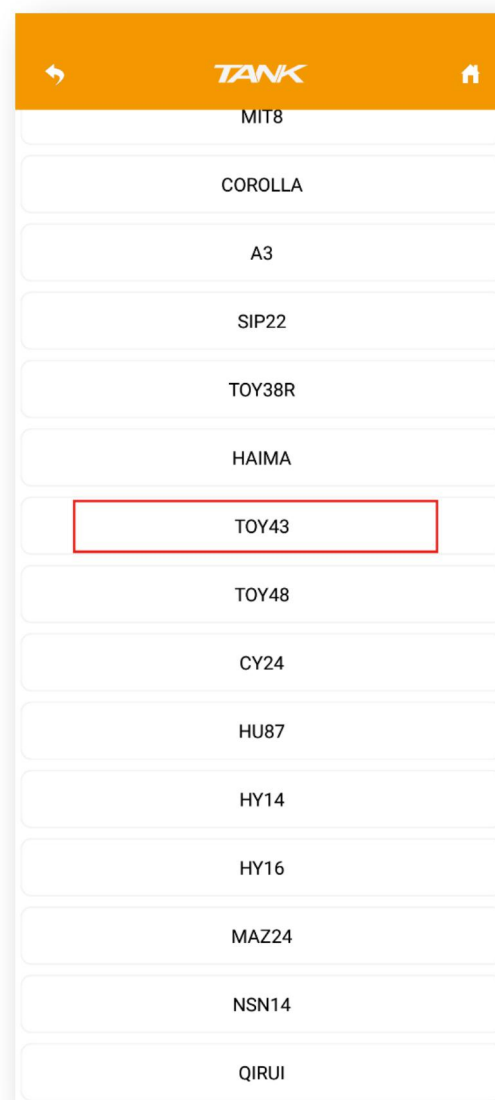

Select key type that corresponds with

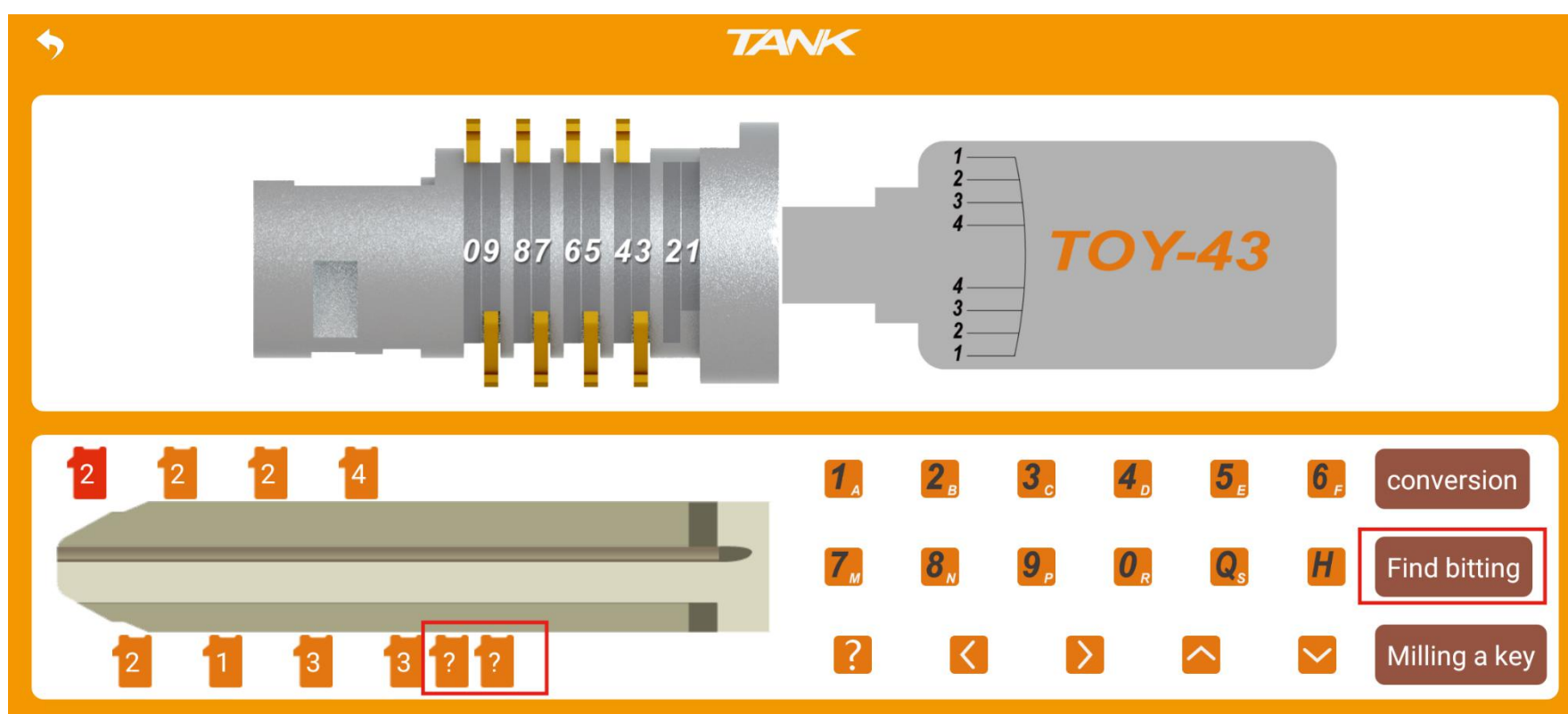

When the key type that you select has ?, it is the cuts that tools can not decode. you can click 'find bitting and cuts appear.

(Notes: When decoding the lock, it's not sure the cuts number, you can click 'find bitting' on the right, cuts number will appear immediately.)

12、 Update

12-1 APP update

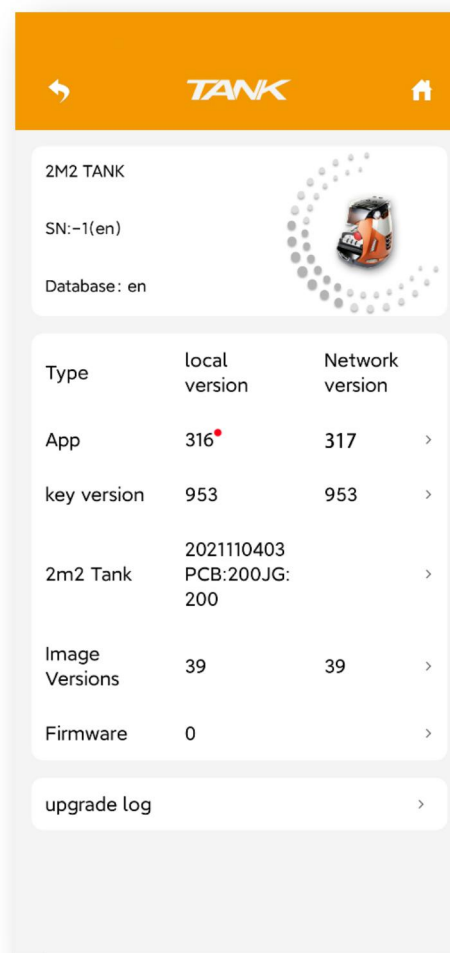
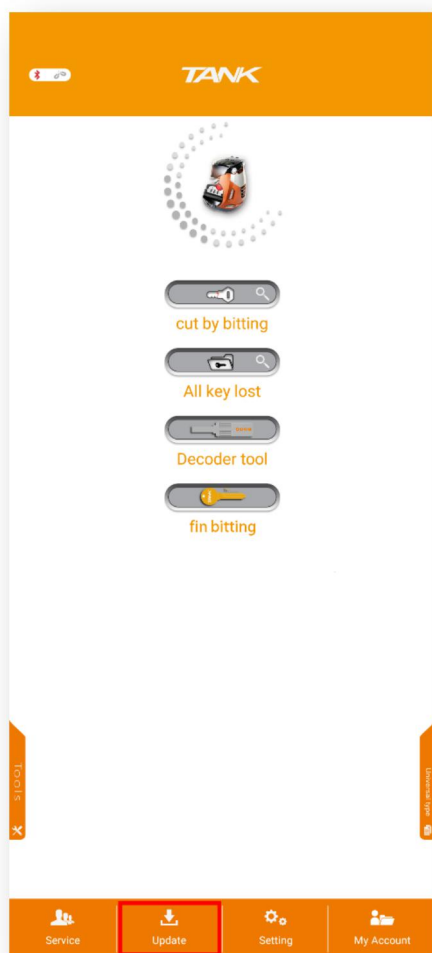

Click 'update'. When APP version number has red point, please click it and update. If not, it's not necessary to update it.

12-2 Update key database

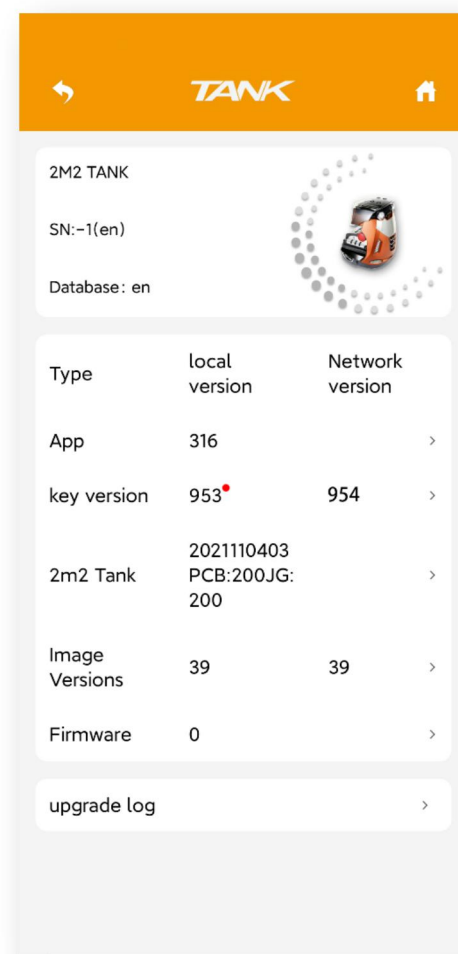
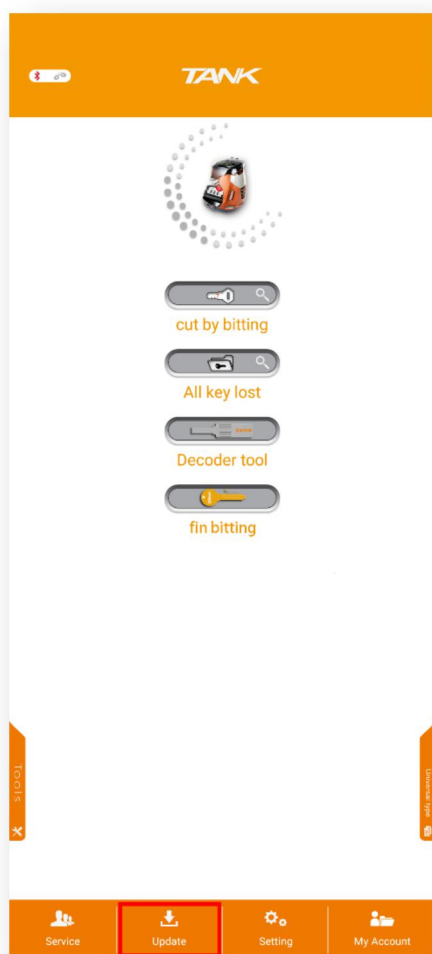

Click 'update'. When the key version number has red point, please click it and update. If not, it's not necessary to update it.

12-3 Firmware update

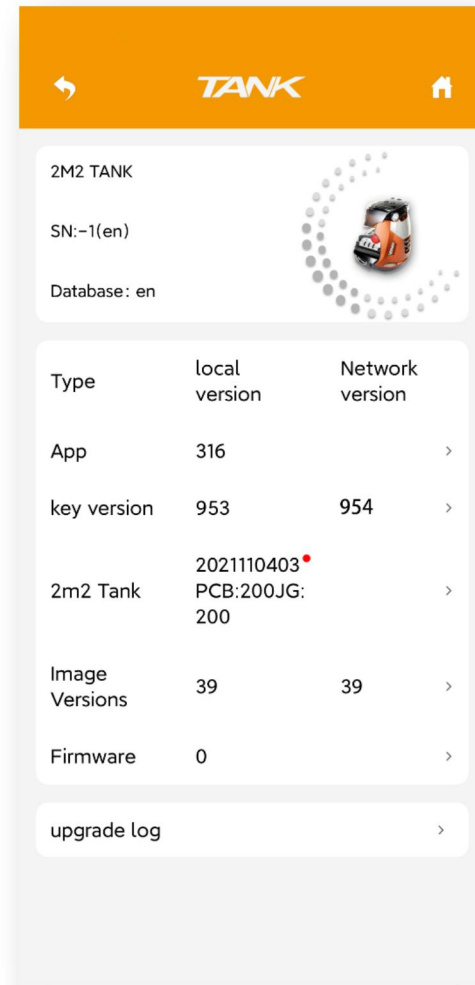
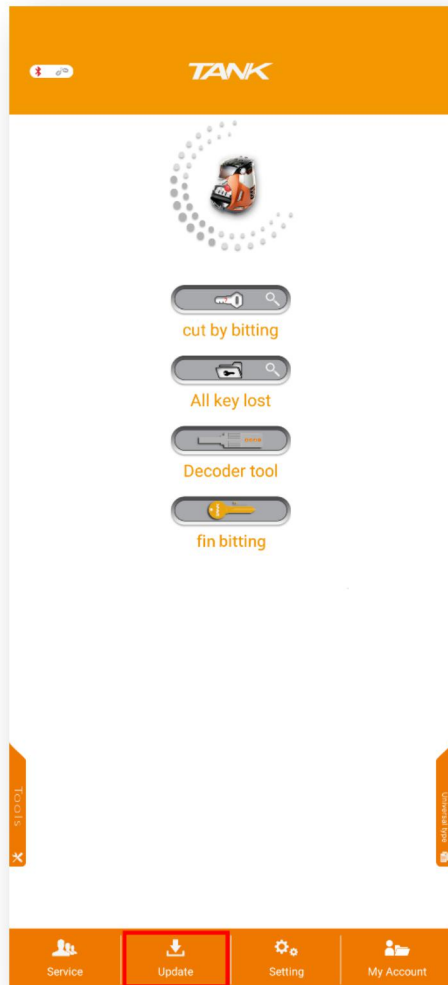

Click 'update'. When 2m2 Tank series number has red point, please click it and update.

If not, it's not necessary to update it.

12-4 Update image

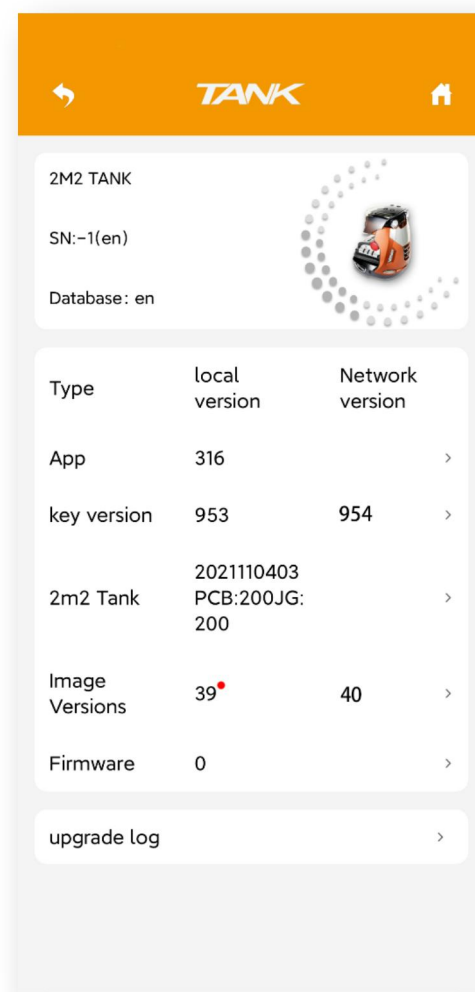
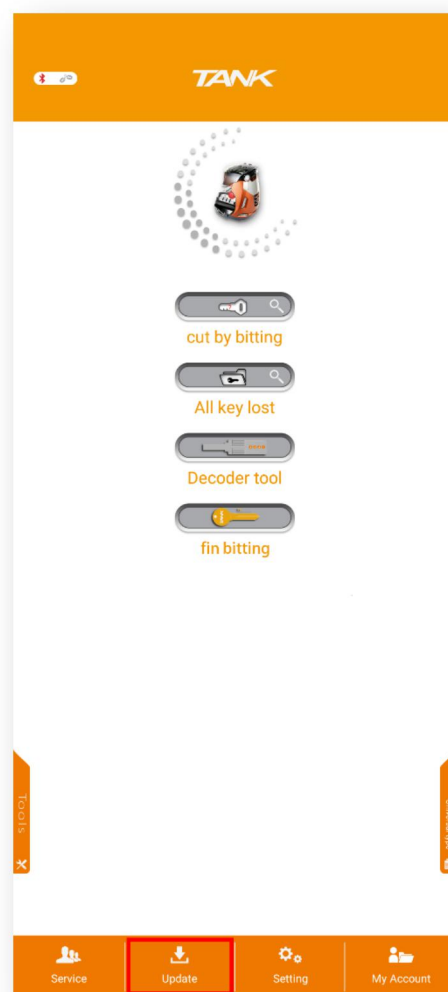

Click 'update'. When image version has red point, please click it and update. If not,

It's not necessary to update.

12-5 Update operation view

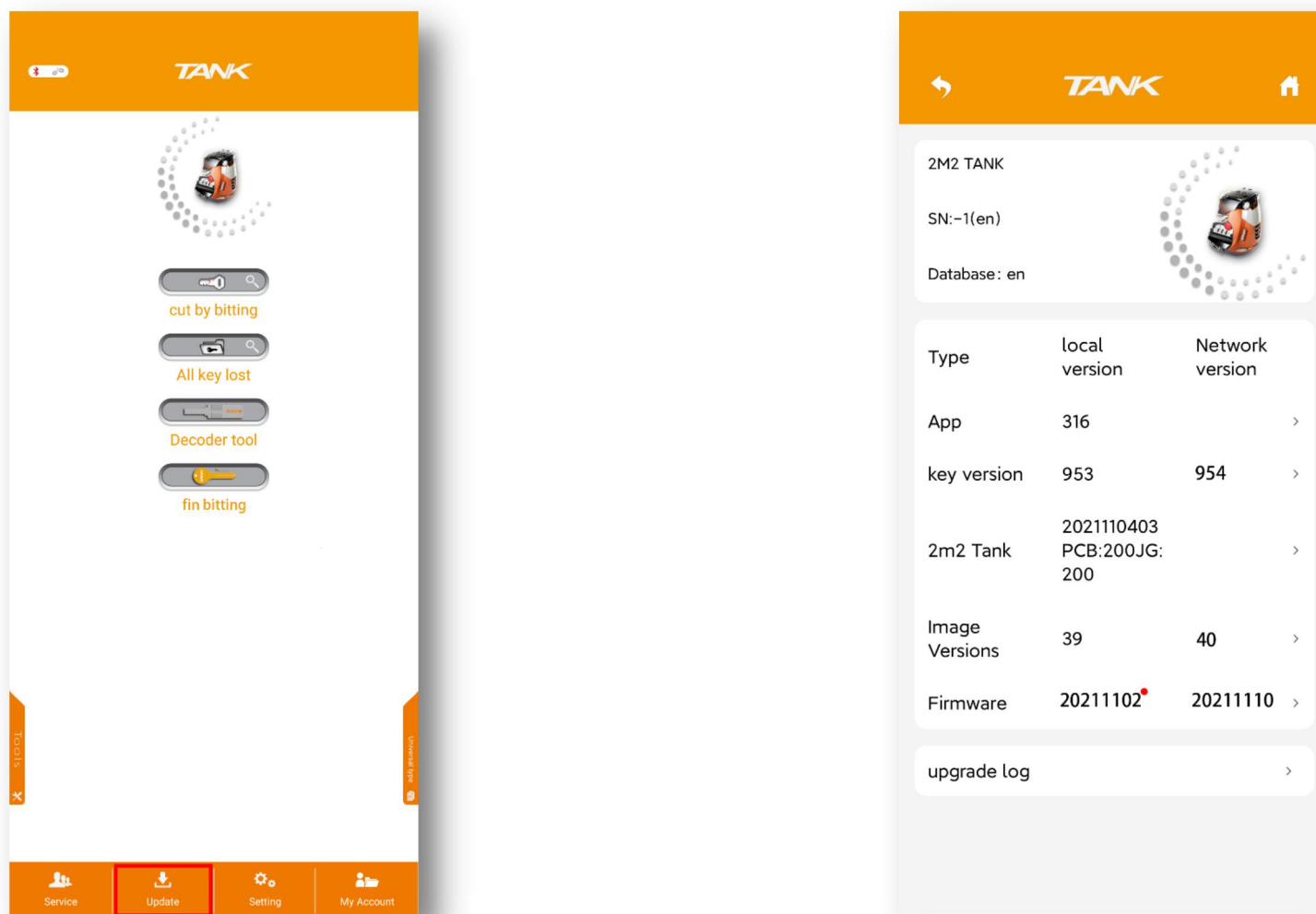

Click 'update'. When firmware series number has red point, please click it and update.

If not, it's not necessary to update.

12-6 Update log

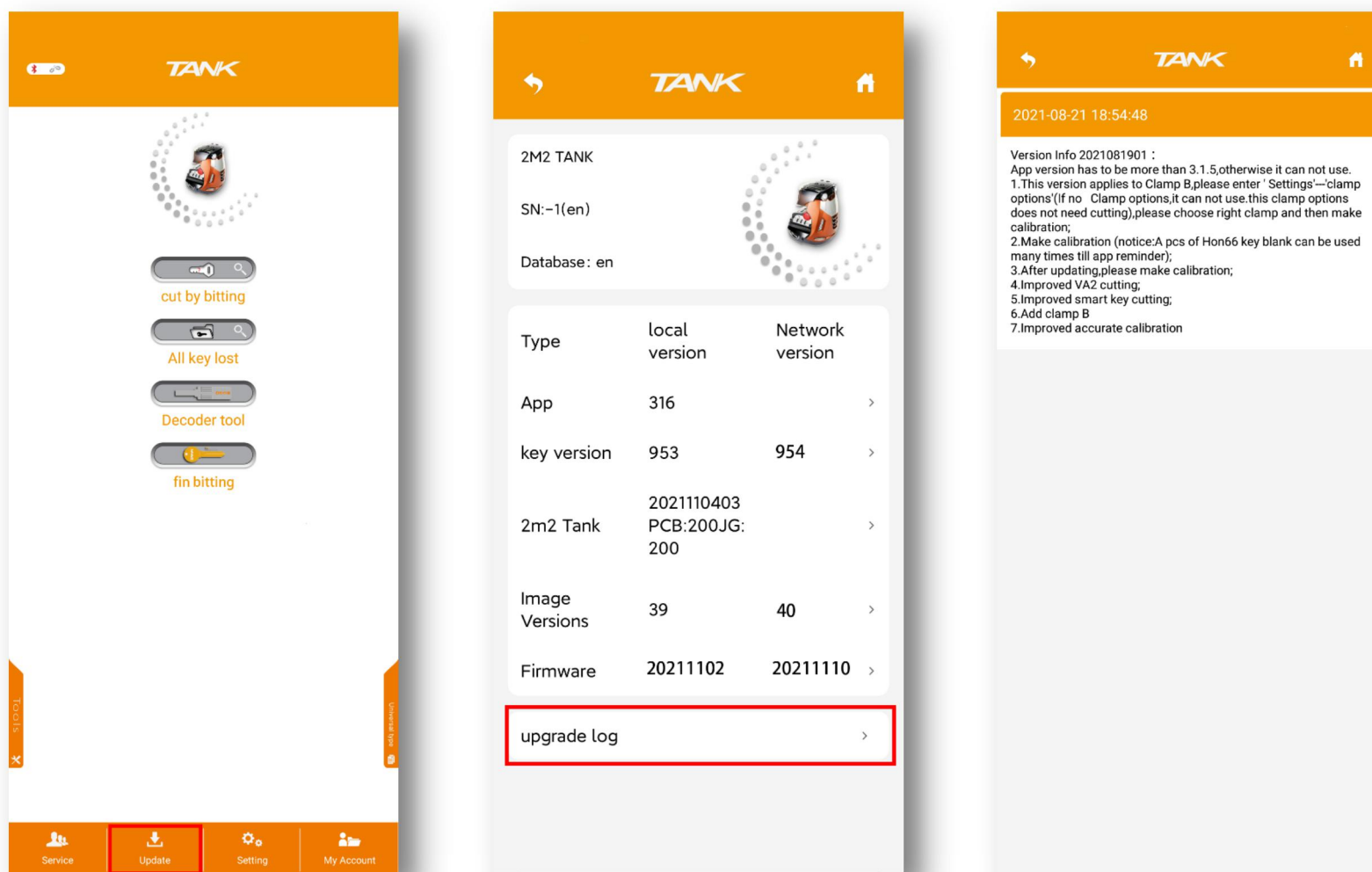

Click 'update log', and enter update information.

13、 Maintenance

- Please clean the area around clamps with a brush before the machine starts to work. This is to assure cutting precision and avoid components damage by metal particles.
- To avoid damage or corrosion to the machine, please do not use detergent or other cleaning products to clean the machine.
- Please do not flush or wet the machine with water, in case rust and electrical current leakage.
- Under any circumstance, please do not try to clean the working area with air guns and drying machines, in case any metal carvings getting inside the machine.

14、 Warranty

2M2 MagicTank has a warranty of 2 year for machine and battery. The warranty starts from the product that you received.

Within warranty, free maintenance and repairing is not provided if the machine becomes dysfunctional due to the following reasons:

- Operation without referring to or violating the user manual
- Modifications or repairs to the machine by individuals
- Falling, knocking or wrong voltage
- Force majeure
- Use of the machine in environment that are bad for the machine for a long time

Thanks for your reading, welcome to use 2M2 tank automatic key cutting machine.